



FSU
Frame Relay Service Unit

USER MANUAL

1200130L1
1200130L2

FSU base unit
FSU w/built-in DSU

This product includes software developed by the University of California, Berkeley,
and its contributors.



901 Explorer Boulevard
P.O. Box 140000
Huntsville, AL 35814-4000
Phone: (205) 963-8000

© 1997 ADTRAN, Inc.
All rights reserved.
Printed in USA.

ABOUT THIS MANUAL

This manual is arranged so you can quickly and easily find the information you need. The following is an overview of the contents of this manual:

- Chapter 1, Introduction, familiarizes you with frame relay networks and FSU highlights and gives a brief explanation of options that may be purchased for use with the FSU.
- Chapter 2, Installation, describes the FSU connectors (pin assignments are given in Appendix A) and provides an installation diagram.
- Chapter 3, Operation, explains how to operate your FSU using either the front panel or a VT 100 terminal interface.
- Chapter 4, Applications, provides examples of some common FSU applications. This chapter includes network diagrams as well as configuration tables for each example.
- Chapter 5, Configuration Overview, explains how to access the FSU configuration menu and provides menu trees for both the front panel and the VT 100 interface.
- Chapters 6 through 9 provide brief explanations for selections made in the Configuration menus. These chapters are based on the first level menu branches of the Configuration menu: DTE Ports 1 and 2, Network Port, IP Routing, and System Configuration.
- Chapter 10, Statistics, describes how to access statistical information from the FSU.
- Chapter 11, Diagnostics, explains how to access the FSU diagnostic features, including Ping and Loopback Tests.
- Appendix A provides pinouts for the FSU connectors.
- Appendix B contains product specifications.



Notes provide additional useful information.



Cautions signify information that could prevent service interruption.



Warnings provide information that could prevent damage to the equipment or endangerment to human life.

FCC regulations require that the following information be provided in this manual:

1. This equipment complies with Part 68 of the FCC rules. On the bottom of the equipment housing is a label that shows the FCC registration number and Ringer Equivalence Number (REN) for this equipment. If requested, provide this information to the telephone company (REN is not required for some types of analog or digital facilities).
2. If this equipment causes harm to the telephone network, the telephone company may temporarily discontinue service. If possible, advance notification is given, otherwise, notification is given as soon as possible. The telephone company will advise the customer of the right to file a complaint with the FCC.
3. The telephone company may make changes in its facilities, equipment, operations, or procedures that could affect the proper operation of this equipment; advance notification and the opportunity to maintain uninterrupted service are given.
4. If experiencing difficulty with this equipment, please contact ADTRAN for repair and warranty information. The telephone company may require this equipment to be disconnected from the network until the problem is corrected or it is certain the equipment is not malfunctioning.
5. This unit contains no user serviceable parts.
6. An FCC compliant telephone cord with a modular plug is provided with this equipment. In addition, an FCC compliant cable appropriate for the dial backup option ordered is provided with this equipment. This equipment is designed to be connected to the telephone network or premises wiring using an FCC compatible modular jack, which is Part 68 compliant.
7. The following information may be required when applying to the local telephone company for leased line facilities:

Service Type	Digital Facility Interface Code	Service Order Code	Network Jacks
56 kbps Digital Interface	04DU5-56	6.0F	RJ-48S
64 kbps Digital Interface	04DU5-64	6.0F	RJ-48S

8. In the event of equipment malfunction, all repairs should be performed by ADTRAN. It is the responsibility of users requiring service to report the need for service to their distributor or ADTRAN. See the inside back cover of this manual for information on contacting ADTRAN for service.

**FEDERAL COMMUNICATIONS COMMISSION
RADIO FREQUENCY INTERFERENCE STATEMENT:**

This equipment has been tested and found to comply with the limits for a Class A digital device, pursuant to Part 15 of the FCC Rules. These limits are designed to provide reasonable protection against harmful interference when the equipment is operated in a commercial environment. This equipment generates, uses, and can radiate radio frequency energy and, if not installed and used in accordance with the instruction manual, may cause harmful interference to radio frequencies. Operation of this equipment in a residential area is likely to cause harmful interference in which case the user will be required to correct the interference at his own expense.

Shielded cables must be used with this unit to ensure compliance with Class A FCC limits.

WARNING

Change or modifications to this unit not expressly approved by the party responsible for compliance could void the user's authority to operate the equipment.

CANADIAN EMISSIONS REQUIREMENTS

This digital apparatus does not exceed the Class A limits for radio noise emissions from digital apparatus as set out in the interference-causing equipment standard entitled "Digital Apparatus," ICES-003 of the Department of Communications.

Cet appareil numérique respecte les limites de bruits radioélectriques applicables aux appareils numériques de Class A prescrites dans la norme sur le matériel brouilleur: "Appareils Numériques," NMB-003 édictée par le ministre des Communications.

CANADIAN EQUIPMENT LIMITATIONS

Notice: The Canadian Industry and Science Canada label identifies certified equipment. This certification means that the equipment meets certain telecommunications network protective, operational, and safety requirements. The Department does not guarantee the equipment will operate to the user's satisfaction.

Before installing this equipment, users should ensure that it is permissible to be connected to the facilities of the local telecommunications company. The equipment must also be installed using an acceptable method of connection. In some cases, the company's inside wiring associated with a single line individual service may be extended by means of a certified connector assembly (telephone extension cord). The customer should be aware that compliance with the above conditions may not prevent degradation of service in some situations.

Repairs to certified equipment should be made by an authorized Canadian maintenance facility designated by the supplier. Any repairs or alterations made by the user to this equipment, or equipment malfunctions, may give the telecommunications company cause to request the user to disconnect the equipment.

Users should ensure for their own protection that the electrical ground connections of the power utility, telephone lines and internal metallic water pipe system, if present, are connected together. This precaution may be particularly important in rural areas.



Users should not attempt to make such connections themselves, but should contact the appropriate electric inspection authority, or an electrician, as appropriate.

The Load Number (LN) assigned to each terminal device denotes the percentage of the total load to be connected to a telephone loop which is used by the device, to prevent overloading. The termination on a loop may consist of any combination of devices subject only to the requirement that the total of the Load Numbers of all devices does not exceed 100.

Table of Contents

Chapter 1. Introduction

Understanding Frame Relay	1
Product Overview	2
DDS Operation	3
56/64k DDS DSU Option	3
SNMP Management	3
Warranty and Customer Service.....	4

Chapter 2. Installation

Unpack, Inspect, Power Up.....	5
Receiving Inspection	5
ADTRAN Shipments Include	5
Customer Provides	5
Power Up	6
Rear Panel	6
DCE Connector	8
DTE Connectors	8
Main Telco Connector	8
Backup Connector	8
Control Port	9

Chapter 3. Operation

Front Panel.....	11
LCD Window	11
Enter	11
Numeric Keypad	11
Shift	11
Cancel.....	12
Up and Down Arrows	12
Next, Prev, Add, Del.....	12
LED Descriptions	15
Front Panel Operation	16
VT 100 Terminal Connection and Operation	17
FSU Menu Structure	19
Main Menu	19
Configuration (CONFIG)	19

View Statistics (STATS)	19
Diagnostics (DIAG)	19
Save Configuration (SAVE)	20
Abort Changes (ABORT)	20
Logout (VT 100 menu only)	20
Chapter 4. Applications	
SNA/SDLC with Local Spoofing	21
SNA and LAN Application with SNMP/Telnet Management	24
Bisync Application	27
Transparent Application	30
Chapter 5. Configuration Overview	
Local and Remote Configuration	33
Chapter 6. DTE Port Configuration	
Port Disabled Protocol (DISABLED)	41
Frame Relay Protocol	42
SDLC Protocol	46
Transparent BOP (TRANS BOP)	51
Bisync Protocol	53
Transparent Async Protocol (TRANS ASYNC)	57
PPP Synchronous Protocol (PPP SYNC)	59
PPP Async Protocol	62
Slip Protocol	65
Chapter 7. Configuring the Network Port	
Network Port	69
Interface Type (INT TYPE)	71
Physical Layer Options (PHYS LYR OPT)	71
Frame Relay Options (FR OPT)	72
LLC2 Options (LLC2 OPT)	74
Local IP Address (LOCAL IP ADDR)	75
Subnet Mask	75
Transmit RIP Requests (XMIT RIP)	75
Process Received RIP Packets	76
Priority Queue Ration (N:1)	76
Chapter 8. IP Routing	
IP Routing With the FSU	77
IP Route Table	79

Example Route Table Entry	80
Gateway IP Address (GW IP ADD)	81
Gateway Port (GW PORT)	81
Gateway DLCI (GW DLCI)	81
Transmit ARP Requests (TX ARP)	81
Process Received ARP Packets (RX ARP)	81
ARP Refresh Time (ARP REF)	81
Chapter 9. System Configuration	
System Config	83
Change Password	84
Read Community Name (RD COM NAME)	84
Write Community Name (WR COM NAME)	84
Trap Manager DLCI (TRAP DLCI)	85
Trap Manager IP Address (TRAP IP ADDR)	85
Trap Manager Port (TRAP PORT)	85
Chapter 10. Statistics	
Viewing Statistical Information with the VT 100 Interface	87
DTE and Network Port Statistics	88
Current Statistics	88
Leads On	88
Total	89
Errors	89
Signal Statistics	90
DLCI Statistics	93
Protocol Statistics	93
Hot Keys	94
ESC	94
DLCI Stats (D)	94
Protocol Stats (P) - DTE and Network Port Menus only	95
Current Stats (C)	95
Freeze Stats (F)	95
Viewing Statistical Information with the Front Panel Interface	96
Statistics Available for DTE and Network Ports	96
Statistics Available Only for the Network Port	98
System Statistics	99
Chapter 11. Diagnostics	
Diagnostics	101

Ping	102
Address to Ping (PING ADDRESS)	102
Start Ping	103
Loopback All Ports (LOOPBACK ENA)	104
Disable Loopbacks (LOOPBACK DIS)	104
Appendix A. Pinouts	105
Appendix B. Specifications Summary	109
Acronyms and Abbreviations	113
Glossary	117
Index	127

List of Tables

Table 4-A	Configuration Settings for SNA/SDLC Application	23
Table 4-B	Configuration Settings for SNA and LAN Application	26
Table 4-C	Configuration Settings for Multi-Point Bisync Application	29
Table 4-D	Configuration Settings for Transparent BOP Application	31
Table 4-E	Configuration Settings for Transparent Async Application	32
Table A-A	DTE/DCE Connector Pin Assignments	106
Table A-B	Main Connector Pin Assignments	107
Table A-C	Control Connector Pin Assignments	107

List of Figures

Figure 2-1	FSU Rear View	7
Figure 3-1	FSU Front Panel	13
Figure 3-2	Example of Basic Menu Travel	16
Figure 3-3	Terminal Login Menu	18
Figure 3-4	Terminal Main Menu	18
Figure 4-1	SNA/SDLC with Local Spoofing	22
Figure 4-2	SNA and LAN Application with SNMP/Telnet Management	25
Figure 4-3	Bisync Point-to-Point	27
Figure 4-4	Bisync Multi-Point	28
Figure 4-5	Transparent BOP Application	30
Figure 4-6	Transparent Async Application	31
Figure 5-1	VT 100 Configuration Menu	34
Figure 5-2	Front Panel Configuration Menu Tree	35

Figure 5-3	VT 100 Configuration Menu Tree	37
Figure 6-1	VT 100 Port Configuration Menu	39
Figure 6-2	Front Panel Protocol Menu Tree	40
Figure 6-3	Port Disabled Menu Tree	41
Figure 6-4	Frame Relay Protocol Menu Tree	43
Figure 6-5	SDLC Protocol Menu Tree	48
Figure 6-6	Transparent BOP Menu Tree	51
Figure 6-7	Bisync Protocol Menu Tree	53
Figure 6-8	Transparent Async Protocol Menu Tree	57
Figure 6-9	PPP Synchronous Protocol Menu Tree	60
Figure 6-10	PPP Asynchronous Protocol Menu Tree	63
Figure 6-11	Slip Protocol Menu Tree	66
Figure 7-1	Network Port Configuration Menu	70
Figure 7-2	VT 100 Network Port Configuration Menu	71
Figure 7-3	VT 100 Network Port Frame Relay Options Menu	72
Figure 7-4	VT 100 Network Port LLC2 Options Menu	75
Figure 8-1	VT 100 IP Route Menu	78
Figure 8-2	IP Routing Table Menu	79
Figure 9-1	System Configuration Menu	84
Figure 10-1	View Statistics Menu	88
Figure 10-2	DTE Port Statistics Menu-Frame Relay Protocol	90
Figure 10-3	DTE Port Statistics Menu-Transparent Async Protocol	91
Figure 10-4	DTE Port Statistics Menu-All Other Protocols	91
Figure 10-5	Network Port View Statistics Menu	92
Figure 10-6	View DLCI Statistics Menu-Network Port and Frame Relay Protocol Only	92
Figure 10-7	Protocol Statistics Menu	94
Figure 10-8	Control Signal Status Screen	96
Figure 10-9	Signal State Screen	98
Figure 10-10	System Statistics Screen	99
Figure 11-1	Diagnostics	101
Figure 11-2	Front Panel Diagnostics Menu	102
Figure 11-3	VT 100 Ping Menu	104

Chapter 1

Introduction

UNDERSTANDING FRAME RELAY

Frame relay is a wide area network (WAN) service designed to minimize physical connections. This is accomplished by using virtual connections within the frame relay cloud and accessing these virtual circuits with normally one physical connection at each location to the frame relay service. Virtual circuits are addressed using header information at the beginning of each frame. These frames are formatted by the user's CPE equipment such as the ADTRAN FSU.

ANSI standards describe how each frame must be constructed to provide interoperability between CPE equipment and frame relay switching equipment. Each frame must contain a header, at least one byte of information data, two bytes of CRC16, and a trailing flag 0x7E.

This header information contains a virtual circuit address known as a DLCI (data link connection identifier). The header information also contains bits used for network congestion control.

Frame relay virtual circuits may be defined as permanent (PVC) or switched (SVC). PVCs have the same DLCI for a given path each time a user protocol session is established. The network service provider assigns these DLCIs at subscription time. SVCs, on the other hand, have DLCIs dynamically assigned each time a user protocol session is established. The CPE equipment must request a call and the DLCI is assigned by the network switching

equipment. This DLCI is valid until the call is disconnected and may be assigned a different value each time a call is requested.

PRODUCT OVERVIEW

The FSU provides a low cost solution for the CPE equipment in a private or public frame relay network. The FSU connects to the frame relay network via 56/64k DDS (digital data service) or T1/FT1 access links. Connections to 56/64k DDS are made using an integral 56/64k DSU or an external DSU. T1/FT1 connections are made using an external T1 DSU/CSU through a V.35 interface.

The FSU provides connections to the user equipment through two independent ports emulating a DCE device. These ports can be configured for either RS-232 or V.35 signal specifications. Synchronous protocol speeds up to 512 kbps and asynchronous protocol speeds up to 38.4 kbps are supported.

The FSU handles each frame of the user data in a three-step manner. The first step is terminating the user protocol. The layer at which this termination occurs varies depending on the user protocol selection for a given port. The next step is examining the user protocol destination address and routing to the destination port and virtual circuit. The last step involves encapsulating the information field of each frame and re-encapsulating based on the destination port configuration. A similar process is used for frame relay frames received on the network port.

The major features of the FSU are as follows:

- Two DTE (data terminal equipment) ports for use on a single frame relay network interface.
- Support for IP (internet protocol), SDLC (synchronous data link control), Bisync, SLIP (serial link IP), PPP (point-to-point protocol) both sync and async, frame relay, BOP (bit-oriented protocol), and async protocols.
- SNMP (simple network management protocol) management capability provided inband with support for RFC 1315 (frame

relay DTE MIB), RFC 1213 (MIB II), and ADTRAN Enterprise MIB.

- DCE port supporting rates of up to 512 kbps.
- Optional integrated 56/64 DDS DSU/CSU.
- Telnet-provided remote terminal management control.
- FLASH code space for easy software upgrades.

DDS OPERATION

DDS is a nationwide service that allows interconnection and transportation of data at speeds up to 64 kbps. The local exchange carriers provide the local loop service to DDS customers and may provide data for routing Inter-LATA to an interexchange carrier. With the optional integrated 56/64 DDS DSU, the FSU supports the 56/64 kbps DDS service rate yielding DTE rates of 2.4, 4.8, 9.6, 19.2, 38.4, 56, and 64 kbps.

56/64K DDS DSU OPTION

The FSU is available with an optional integrated 56/64k DSU (part number 1200130L2). This gives the unit the ability to directly connect to a frame relay network via a 56 or 64k DDS circuit.

SNMP MANAGEMENT

SNMP management capability is provided inband with support for RFC 1315 (frame relay DTE MIB), RFC 1213 (MIB II), and ADTRAN Enterprise MIB. Telnet capability is also supported. For non-SNMP environments, VT 100 and front panel operation is supported.

WARRANTY AND CUSTOMER SERVICE

ADTRAN will replace or repair this product within five years from the date of shipment if it does not meet its published specifications or fails while in service. For detailed warranty, repair, and return information refer to the ADTRAN Equipment Warranty and Repair and Return Policy Procedure.

Return Material Authorization (RMA) is required prior to returning equipment to ADTRAN.

For service, RMA requests, or further information, contact one of the numbers listed on the inside back cover of this manual.

Chapter 2

Installation

UNPACK, INSPECT, POWER UP

Receiving Inspection

Carefully inspect the FSU for any damage that may have occurred in shipment. If damage is suspected, file a claim immediately with the carrier and contact ADTRAN Customer Service (see the back cover of this manual). Keep the original shipping container to use for future shipment or verification of damage during shipment.

ADTRAN Shipments Include

The following items are included in ADTRAN shipments of the FSU:

- FSU unit
- User manual
- An 8-position modular to 8-position modular cable if the integrated DSU option is installed (part number 1200130L2)
- VT 100 terminal adapter cable (consists of a DB-25 modular adapter and an 8-position to 8-position modular cable)

Customer Provides

The customer provides an interface cable for each port used. Each cable should be either an RS-232 with a standard 25-pin male D-type connector or a V.35 cable. V.35 requires an ADTRAN adapter cable (part numbers: male 1200193L1; female 1200194L1).

Power Up

Each FSU unit is provided with a captive eight-foot power cord, terminated by a three-prong plug which connects to a grounded 115 VAC power receptacle.



Power to the FSU must be provided from a grounded 115 VAC, 60 Hz receptacle.

REAR PANEL

The FSU is equipped with three DB-25 connectors labeled **DTE 1**, **DTE 2**, and **DCE**. Connections to the dedicated circuit, dial backup circuit (future enhancement), and VT 100 interface are provided through the 8-pin telco jacks labeled **MAIN**, **BACKUP**, and **CONTROL**. Pin assignments for these connectors are given in the appendix *Pinouts*. The FSU rear panel is shown in Figure 2-1.



The FSU base unit (part number 1200130L1) is not equipped with an internal DSU. Therefore, the MAIN and BACKUP connectors are not provided.



The BACKUP connector is provided for future enhancements (FSU dial backup options).

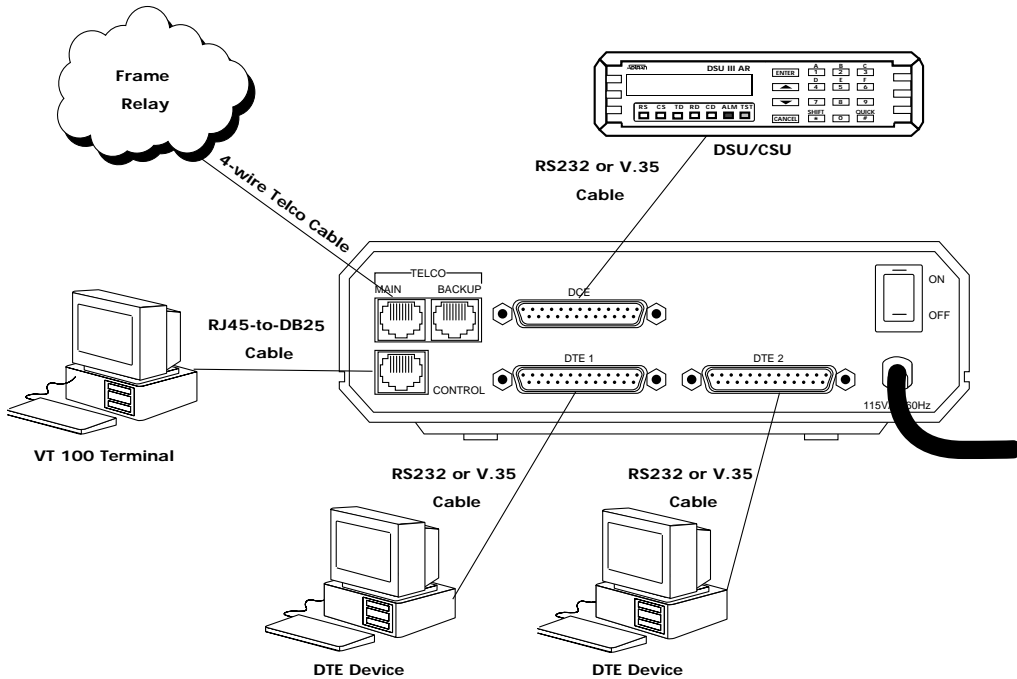

Item	Function
DCE port	Connects to an external DSU/CSU
DTE 1 port	Connects to a DTE device
DTE 2 port	Connects to a DTE device
Main telco connector	Connects to the dedicated circuit
Backup telco connector	Connects to the dial backup circuit (future enhancement)
Control port	Connects to the VT 100 interface
On/Off Switch	Turns power on and off
115 VAC connection	Connects to captive power cord

Figure 2-1
FSU Rear View

DCE Connector

The connector labeled DCE provides connection to an external DSU/CSU. The pinouts for this connector are shown in the appendix *Pinouts*.



The connection between the FSU and an external DSU is a direct connection. When connecting to an external DSU, the FSU emulates an externally timed DTE interface connected directly to the DCE interface of the external device.

DTE Connectors

DTE devices are connected to the DTE connectors using either an RS-232 DTE cable or a CCITT V.35 DTE adapter cable. The maximum cable lengths recommended are 50 feet for the RS-232 and 100 feet for the CCITT V.35. The pin assignments are listed in the appendix *Pinouts*.

The V.35 adapter cable is recommended for use with data rates above 19.2 kbps. A low capacitance RS-232 cable works up to 56 kbps. The DTE ports are configured through the front panel or the VT 100 control port. The DTE ports can operate in asynchronous or synchronous modes.

Main Telco Connector

The **Main** connector is an eight-position modular jack which provides connection to the dedicated (DDS) network. See the appendix *Pinouts* for the **Main** connector's pin assignments.

Backup Connector

The eight-position modular jack labeled **BACKUP** is provided to allow future enhancements to the FSU (dial backup options). With the dial backup option installed, this connector will provide connection to the switched telco circuit.

Control Port

The eight-position modular jack labeled **CONTROL** provides connection to a VT 100 RS-232 compatible interface. This enables the FSU to be configured through a terminal instead of the front panel. Use the VT 100 terminal cable (provided) for this connection. See the appendix *Pinouts* for the connector pin assignments. A description of the operation of this port is covered in the chapter *Operation*.

Chapter 3

Operation

FRONT PANEL

The FSU faceplate is shown in Figure 3-1. Descriptions of each part of the front panel follow.

LCD Window

Displays menu items and messages in 2 lines by 16 characters.

Enter

Selects active menu items. To activate a menu item scroll to it using the arrow keys, or press the number of the item. The flashing cursor indicates which parameter is activated. Press **Enter** to select the active menu item.

Numeric Keypad

The numeric keypad contains the numbers 0 through 9 and alpha characters A through F, which are used to activate menu items and enter information (such as the IP address).

Shift

Enter alpha characters by pressing **Shift** before each desired character. The **NEXT**, **PREV**, **ADD**, and **DEL** keys are also activated by first pressing **Shift**.

To activate a menu item designated by an alpha character rather than a number, place the cursor on the menu item using the **Up** and **Down Arrows** or press **Shift** and then the letter. The flashing cursor indicates which parameter is activated. Press **Enter** to select the item.

If a key is pressed without using **Shift**, the numbered item becomes active instead of the alpha item. If this happens, repeat the correct procedure.

Cancel

Pressing the **Cancel** key stops the current activity and returns to the previous menu. Repeat until the desired menu level is reached. When a submenu item is displayed, press **Cancel** to exit the current display and return to the previous menu.

Up and Down Arrows

Up and **Down Arrows** scroll through and activate the submenu items available in the current menu. When the submenu items are scrolled, the flashing cursor indicates the active parameter.

Next, Prev, Add, Del

To activate these functions, press and release the **Shift** key, then press the **NEXT**, **PREV**, **ADD**, or **DEL** key. Use these keys when editing routing tables. See the chapters *DTE Port Configuration* and *Configuring IP Routing* for more information.

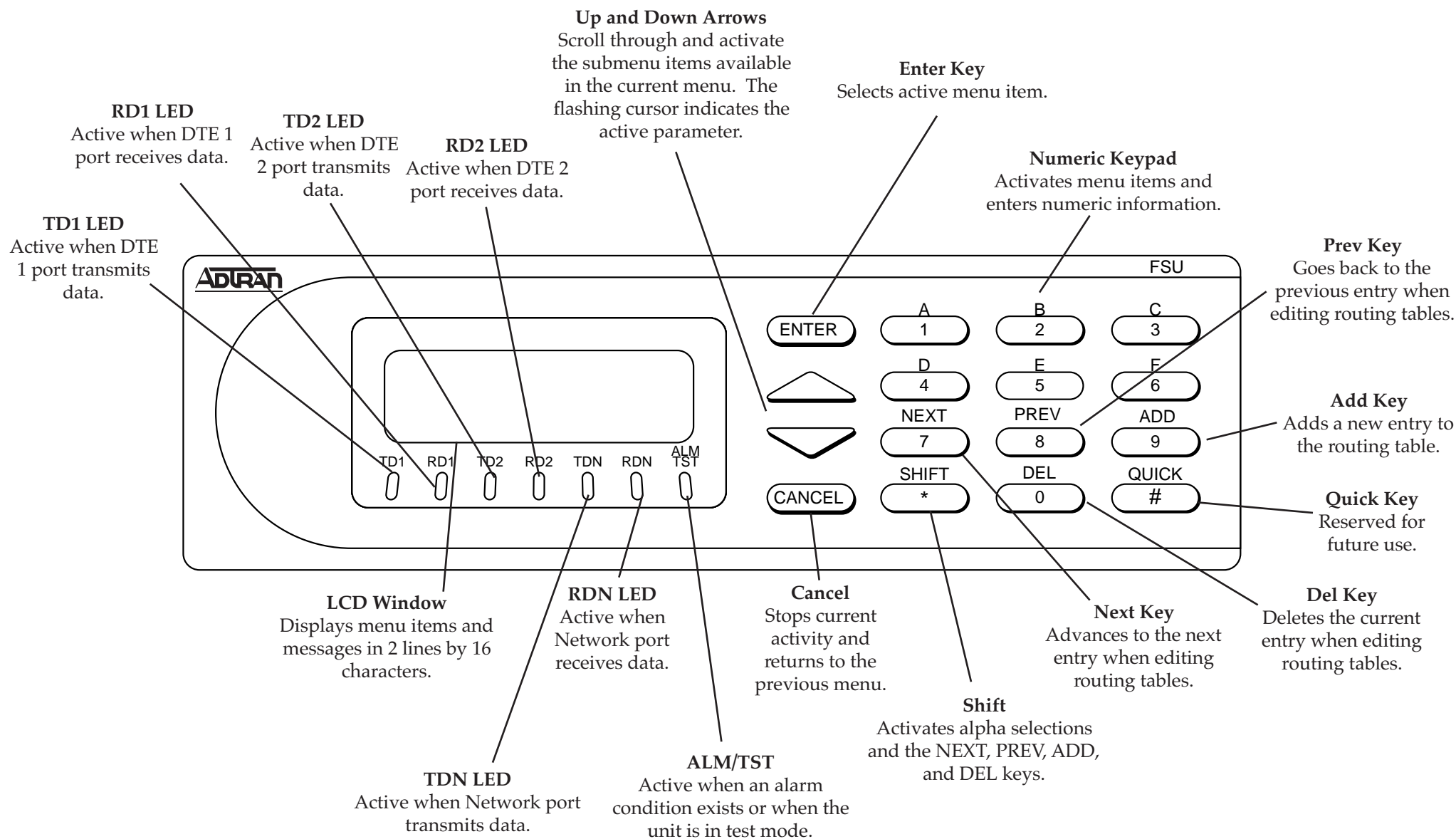

Figure 3-1
FSU Front Panel

LED Descriptions

The FSU has seven LED indicators: TD1, RD1, TD2, RD2, TDN, RDN, and ALM/TST. These LEDs are identified as follows:

TD1: Transmit Data (DTE 1)

This LED is active when the FSU DTE 1 port is transmitting data.

RD1: Receive Data (DTE 1)

This LED is active when the FSU DTE 1 port is receiving data.

TD2: Transmit Data (DTE 2)

This LED is active when the FSU DTE 2 port is transmitting data.

RD2: Receive Data (DTE 2)

This LED is active when the FSU DTE 2 port is receiving data.

TDN: Transmit Data (Network)

This LED is active when the FSU Network port is transmitting data.

RDN: Receive Data (Network)

This LED is active when the FSU Network port is receiving data.

ALM/TST: Alarm/Test

This LED is active when an alarm condition exists or when the unit is in test mode. Alarm conditions include:

DDS Alarm Conditions

- Open loop on network
- No frame synchronization

Frame Relay Alarm Condition

- Network frame relay signaling state is down.

External DSU/CSU Alarm Condition

- DSR on an external DSU/CSU is false.

Front Panel Operation

To choose a menu item, press the corresponding number or alpha character on the keypad. Press **Shift** to activate menu items with alpha selections. Scrolling to the selection by pressing either the **Up** or **Down Arrow** also activates the menu items. The flashing cursor indicates which selection is activated. Press **Enter** to select the item. The following steps and Figure 3-2 illustrate how to select FSU options:

1. Activate Configuration (CONFIG) using the arrow keys or by pressing **1**. The cursor will flash on the number next to the activated selection. Press **Enter**.
2. Use the arrow keys to view submenu items.
3. Choose an item on the submenu such as DTE PORT 1.
4. Activate DTE PORT 1 using the arrow keys or by pressing **1**. Press **Enter**.
5. Activate PROTOCOL options using the arrow keys or by pressing **1**. Press **Enter**.
6. Press the arrow keys until the desired protocol is displayed. Press **Enter**.

1 CONFIG	1 DTE PORT 1	1 PROTOCOL	1 PORT DISABLED
	2 DTE PORT 2	2 PHYS LVR OPT	2 FRAME RELAY
	3 NETWORK PORT	3 PROTOCOL OPT	3 SDLC <> LLC2
	4 CONTROL PORT	4 ADDRESS TABLE	4 TRANSPARENT BOP
	5 IP ROUTING		5 BISYNC
	6 UNIT CONFIG		6 TRANSPARENT ASYNC
			7 PPP SYNCHRONOUS
			8 PPP ASYNC
			9 SLIP

Figure 3-2
Example of Basic Menu Travel

VT 100 Terminal Connection and Operation

To control the FSU using a VT 100 terminal, perform the following procedure:

1. Set the FSU baud rate to match the terminal through the front panel. Select **1 CONFIG**, then **4 CONTROL PORT**.
2. Using the provided VT 100 terminal adapter cable, connect the COM port of a VT 100 compatible terminal or equivalent to the eight-pin modular jack labeled CONTROL on the rear of the FSU. This connection is used for both local and remote configuration.
3. Open the connection and press **Enter** repeatedly until the Login Menu appears (Figure 3-3).
4. Select Local Login to configure the FSU unit connected to the terminal. Select Remote Login to configure a remotely located FSU unit. For remote applications, enter the DLCI (data link connection identifier) number of the remote unit by pressing **1**, **Enter**, the DLCI number, and **Enter** again. Next select Begin Remote Session by pressing **2** and **Enter**.
5. Enter the password. The factory default password is **adtran**. The Main menu will appear (Figure 3-4).
6. Make selections by entering the number corresponding to the chosen parameter. Press **ESC** to return to the previous screen.



In the upper right-hand corner of the VT 100 screen, LOCAL or REMOTE is displayed, indicating which unit the current screen represents. See Figure 3-3.

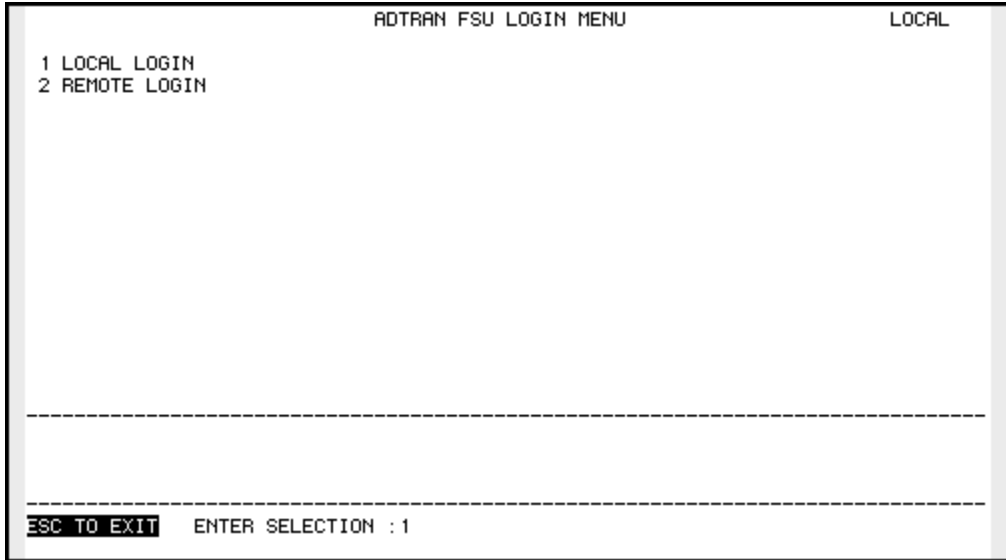

Figure 3-3
Terminal Login Menu

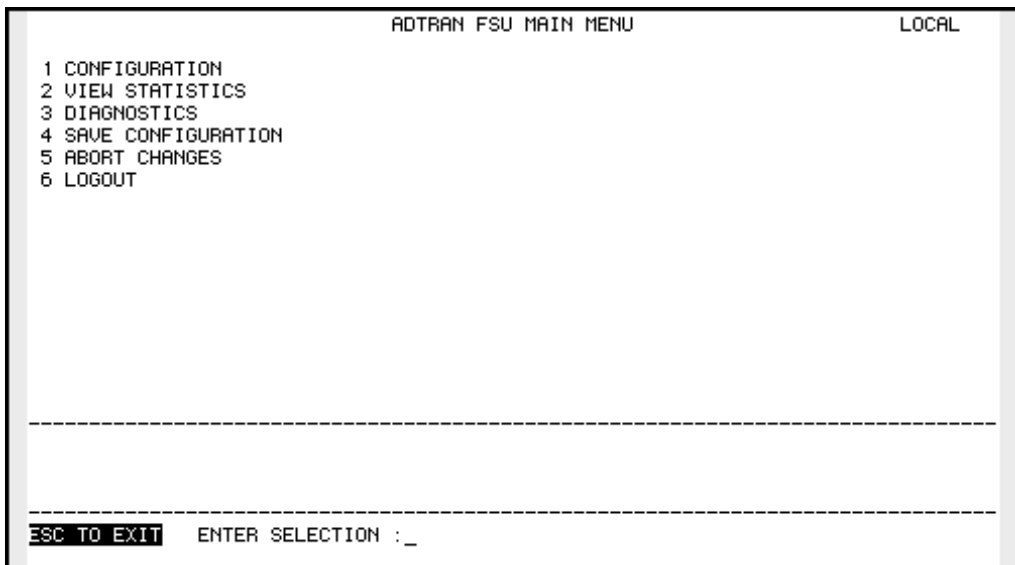

Figure 3-4
Terminal Main Menu

FSU MENU STRUCTURE

The opening menu is the access point to all other operations. The Main menu branches are Configuration, Statistics, Diagnostics, Save, Abort, and Logout. See Figure 3-2. Each Main menu item has several functions and submenus to identify and access specific parameters.

**NOTE**

The Logout selection is available on the VT 100 interface only.

**NOTE**

In this chapter, the VT 100 selections are listed first followed by the Front Panel selections (if the names differ).

Main Menu

Definitions for the branches of the Main menu follow:

Configuration (CONFIG)

Configuration is used to select network and DTE operating parameters. For more information on configuration options, see the following chapters: *Configuration Overview*, *DTE Port Configuration*, *Configuring the Network Port*, *Configuring IP Routing*, and *System Configuration*. When DTE Port 1 or 2 is selected, the PROTOCOL enabled determines the selections for PHYSICAL LAYER OPTIONS, PROTOCOL OPTIONS, and PROTOCOL ADDRESS TABLE.

View Statistics (STATS)

This selection displays statistical information for DTE ports, the network port, the protocol, and the system. See the chapter *Statistics* for more information.

Diagnostics (DIAG)

Diagnostic options enable and disable loopback and ping functions. See the chapter *Diagnostics* for more information.

Save Configuration (SAVE)

This parameter saves the currently selected configuration.



Configuration changes are not implemented until the Save Configuration (SAVE) option is selected.

Abort Changes (ABORT)

This parameter cancels the current selections and reverts to the last saved configuration.

Logout (VT 100 menu only)

This parameter logs out of the system.

Chapter 4

Applications

This chapter provides examples of some common FSU applications. The examples include SNA/SDLC with local spoofing, SNMP/Telnet management, bisync point-to-point and multi-point, and transparent applications. The configuration selections given in these examples may need modification based on your network configuration.

SNA/SDLC with Local Spoofing

When used in an SNA/SDLC network, the FSU provides local spoofing by emulating the primary or secondary SDLC roles (see Figure 4-1). The FSU performs conversion from SDLC to frame relay and also terminates SDLC links, providing primary and secondary emulation between FSUs. Local spoofing improves performance by reducing traffic across the frame relay network and allows definite response times on the SDLC links.

To perform spoofing, the FSU automatically sets itself up to provide primary or secondary emulation based on the receipt of SNRM (set normal response mode) from an SDLC device. The FSU looks for SNRM on all ports and assumes a secondary role once SNRM is received. The FSU then brings up the LLC2 link across the frame relay network to another FRAD which assumes a primary role. This allows the FSU to operate with PU 2.1 devices.

Different roles can be assumed for each SDLC session. Disconnection starts the role determination procedure again.



In all cases, the FSU is transparent to the XID (exchange identification) negotiation between any two network devices.

The FSU uses LLC protocol (mode 2) to transport SDLC information frames. This protocol ensures a reliable link across frame relay, providing protection from frame loss and excessive delays. The encapsulation method uses the RFC 1490 format. See Table 4-A for an example of how to configure the FSU for this application.

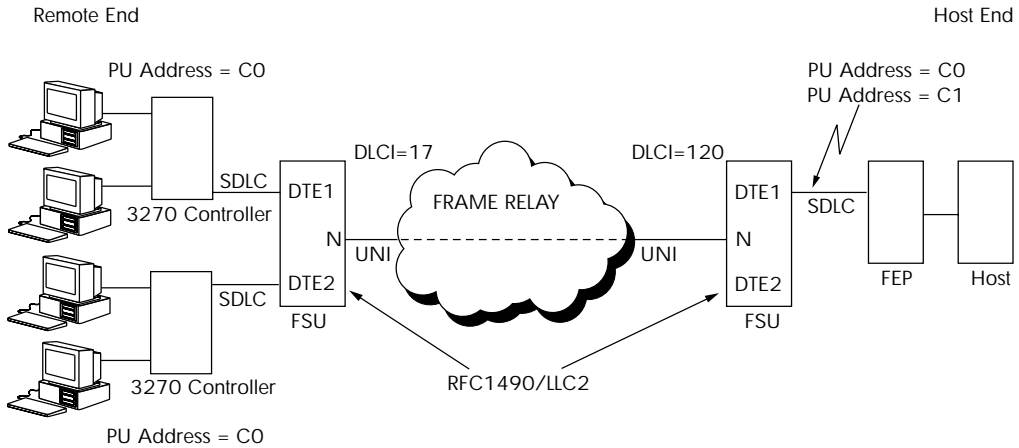

Figure 4-1
SNA /SDLC with Local Spoofing

Table 4-A
Configuration Settings for SNA/SDLC Application

	HOST FSU	REMOTE FSU
DTE Port 1		
Protocol	SDLC	SDLC
Physical Layer Options	CONN=RS232 RATE=19.2K IDLE=ONES	CONN=RS232 RATE=19.2K IDLE=ONES
Protocol Options	FORMAT=NRZ TIMEOUT=3 MIN POLL TIME=0 THRESHOLD=10 POLL RATIO=1 TX DELAY=0	FORMAT=NRZ TIMEOUT=3 MIN POLL TIME=0 THRESHOLD=10 POLL RATIO=1 TX DELAY=0
Protocol Address Table	ENTRY #1 CTRL ADDR=C0 GROUP ADDR=0 LLC2 SSAP=04 LLC2 DSAP=04 OUT DLCI=120	ENTRY #2 CTRL ADDR=C1 GROUP ADDR=0 LLC2 SSAP=08 LLC2 DSAP=04 OUT DLCI=120
		ENTRY #1 CTRL ADDR=C0 GROUP ADDR=0 LLC2 SSAP=04 LLC2 DSAP=04 OUT DLCI=17
DTE Port 2		
Protocol	DISABLED	SDLC
Physical Layer Options	N/A	CONN=RS232 RATE=19.2K IDLE=ONES
Protocol Options	N/A	FORMAT=NRZ TIMEOUT=3 MIN POLL TIME=0 THRESHOLD=10 POLL RATIO=1 TX DELAY=0
Protocol Address Table	N/A	ENTRY #1 CTRL ADDR=C1 GROUP ADDR=0 LLC2 SSAP=04 LLC2 DSAP=08 OUT DLCI=17
Network Port		
Interface Type	V.35	NET
Physical Layer Options	BIT RATE=64K	LOOP RATE=64K CLOCK SOURCE=SLAVE
Frame Relay Options	SIGNAL TYPE=ANNEX D T391=10 N391=6 N392=3 N393=4	SIGNAL TYPE=ANNEX D T391=10 N391=6 N392=3 N393=4

SNA and LAN Application with SNMP/Telnet Management

When used in a mixed environment consisting of both SNA and LAN networks, the FSU serves as a concentrator, allowing both networks access to one frame relay link. The example shown in Figure 4-2 shows DTE 1 configured for SDLC protocol (as in the previous example). DTE 2 is configured for frame relay protocol, providing the LAN gateway/router with frame relay access.

The FSU routes data at the DLCI level using the DTE 2 frame relay address table. The FSU emulates the network end of the UNI signaling protocol for the DTE port while emulating the CPE end for the network port. PVC status information from the frame relay network is stored and used for full status requests from the router attached to the DTE port.

A local DLCI is set up between the router and the FSU. This Management DLCI carries the SNMP and telnet traffic destined for the FSU. This DLCI is included in the UNI full status responses to the router. The FSU IP address must be mapped to the management DLCI in the LAN router's route table (see the following note). With this path, an SNMP manager located anywhere in the network can access the FSU's SNMP and telnet information. See Table 4-B for an example configuration.



NOTE

RIP and inverse ARP are not used for the FSU DTE frame relay port.

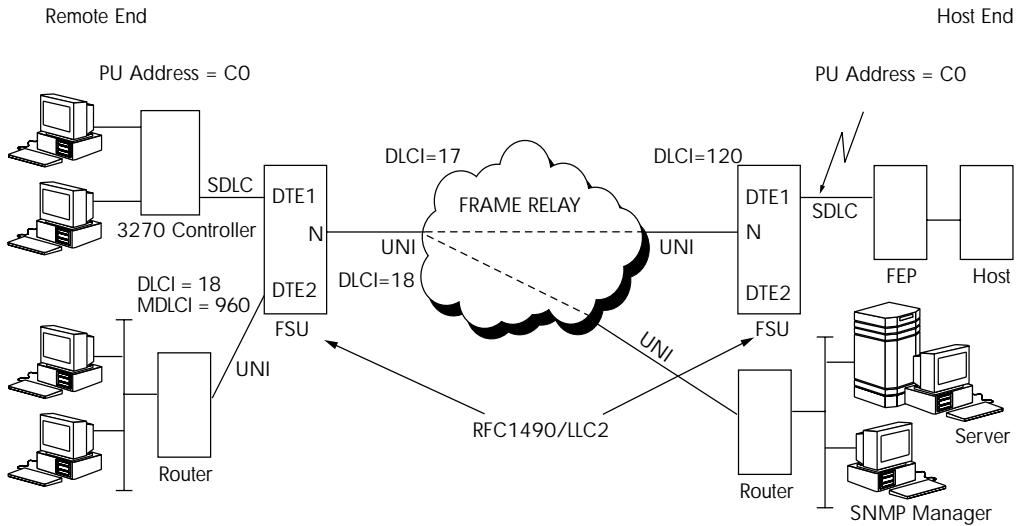

Figure 4-2
SNA and LAN Application with SNMP/Telnet Management

Table 4-B
Configuration Settings for SNA and LAN Application

	HOST FSU	REMOTE FSU
DTE Port 1		
Protocol	SDLC	SDLC
Physical Options	CONN=RS232 RATE=19.2K IDLE=ONES	CONN=RS232 RATE=19.2K IDLE=ONES
Protocol Options	FORMAT=NRZ TIMEOUT=3 MIN POLL TIME=0 THRESHOLD=10 POLL RATIO=1 TX DELAY=0	FORMAT=NRZ TIMEOUT=3 MIN POLL TIME=0 THRESHOLD=10 POLL RATIO=1 TX DELAY=0
Protocol Address Table	ENTRY #1 CTRL ADDR=C0 GROUP ADDR=0 LLC2 SSAP=04 LLC2 DSAP=04 OUT DLCI=120	ENTRY #1 CTRL ADDR=C0 GROUP ADDR=0 LLC2 SSAP=04 LLC2 DSAP=04 OUT DLCI=17
DTE Port 2		
Protocol	DISABLED	FRAME RELAY
Physical Options	N/A	CONN=V.35 RATE=64K IDLE=FLAGS HDW FLOW CTRL=ON
Protocol Options	N/A	SIGNAL=ANSI T392=15 N392=3 N393=4 IP ADDR=200.200.200.2 SUBNET MASK=255.255.255.0 MNG DLCI=960
Protocol Address Table	N/A	PORT DLCI=18 NET DLCI=18
Network Port		
Interface Type	NET	NET
Physical Options	LOOP RATE=64K CLOCK SOURCE=SLAVE	LOOP RATE=64K CLOCK SOURCE=SLAVE
Frame Relay Options	SIGNAL TYPE=ANNEX D T391=10 N391=6 N392=3 N393=4	SIGNAL TYPE=ANNEX D T391=10 N391=6 N392=3 N393=4

Bisync Application

The FSU can be used to connect IBM 3780/2780 (see IBM manual number GA27-3004-2) bisync controllers and a host across a frame relay network. Point-to-point and multi-point configurations are supported at speeds up to 19200 bps. The LLC protocol (mode 2) is used to provide a reliable transport layer across the frame relay network. In a multi-point configuration the FSU performs local spoofing, minimizing traffic across the frame relay network. Sample network illustrations for both point-to-point and multi-point are shown in Figures 4-3 and 4-4.

See Table 4-C for an example configuration for the point-to-point application.

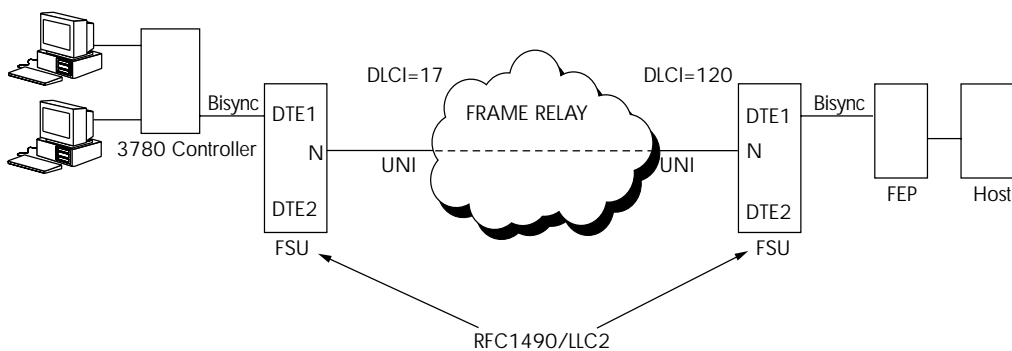

Figure 4-3
Bisync Point-to-Point

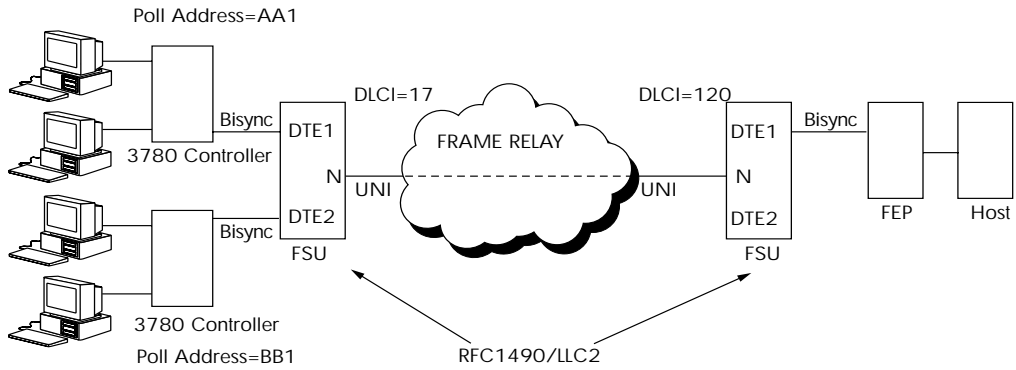

Figure 4-4
Bisync Multi-Point

Table 4-C
Configuration Settings for Multi-Point Bisync Application

	HOST FSU		REMOTE FSU
DTE Port 1			
Protocol	BISYNC		BISYNC
Physical Options	CONN=RS232 RATE=9600		CONN=RS232 RATE=9600
Protocol Options	LINE=MULTIPOINT TRANS CODE= EBCDIC CRC16 FORMAT=NRZ TIMEOUT=3 THRESHOLD=10 POLL RATIO=1		LINE=MULTIPOINT TRANS CODE= EBCDIC CRC16 FORMAT=NRZ TIMEOUT=3 THRESHOLD=10 POLL RATIO=1
Protocol Address Table	ENTRY #1 UNIT ADDR=AA1 LLC2 SSAP=04 LLC2 DSAP=04 OUT DLCI=120	ENTRY #2 UNIT ADDR=BB1 LLC2 SSAP=04 LLC2 DSAP=08 OUT DLCI=12	ENTRY #1 UNIT ADDR=AA1 LLC2 SSAP=04 LLC2 DSAP=04 OUT DLCI=17
DTE Port 2			
Protocol	BISYNC		BISYNC
Physical Options	CONN=RS232 RATE=9600		CONN=RS232 RATE=9600
Protocol Options	LINE=MULTIPOINT TRANS CODE= EBCDIC CRC16 FORMAT=NRZ TIMEOUT=3 THRESHOLD=10 POLL RATIO=1		LINE=MULTIPOINT TRANS CODE= EBCDIC CRC16 FORMAT=NRZ TIMEOUT=3 THRESHOLD=10 POLL RATIO=1
Protocol Address Table	ENTRY #1 UNIT ADDR=AA1 LLC2 SSAP=04 LLC2 DSAP=04 OUT DLCI=120	ENTRY #2 UNIT ADDR=BB1 LLC2 SSAP=04 LLC2 DSAP=08 OUT DLCI=12	ENTRY #1 UNIT ADDR=BB1 LLC2 SSAP=08 LLC2 DSAP=04 OUT DLCI=17
Frame Relay Options	SIGNAL TYPE=ANNEX D T391=10 N391=6 N392=3 N393=4		SIGNAL TYPE=ANNEX D T391=10 N391=6 N392=3 N393=4

Transparent Application

In cases when the user protocol is not supported by the FSU, the transparent mode may be used. Transparent bit-oriented protocol (BOP) or transparent asynchronous protocol may be selected. This can be used for point-to-point connections only because the FSU is transparent to the protocol address formats.

In the transparent BOP protocol, the FSU accepts an HDLC-like protocol and encapsulates the information field of the HDLC frames, transporting them across the frame relay network to the specified virtual circuit and remote FSU port number. The incoming frames must be spaced with at least one flag byte (0x7E) and contain two bytes of CRC16 at the end of each frame.

Asynchronous protocols are supported by using the transparent async mode. The FSU buffers async characters and encapsulates the data portion of each character for transport across frame relay using a programmable DLCI and remote FSU port number.

See Figure 4-5 and Table 4-D for an example of a transparent BOP configuration. See Figure 4-6 and Table 4-E for an example of a transparent asynchronous application.

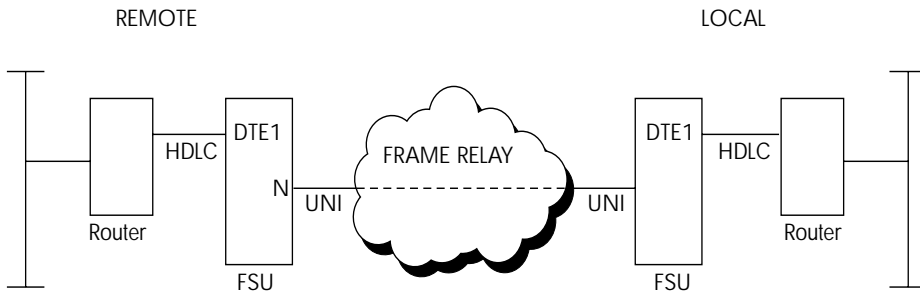

Figure 4-5
Transparent BOP Application

Table 4-D
Configuration Settings for Transparent BOP Application

	HOST FSU	REMOTE FSU
DTE Port 1		
Protocol	TRANS BOP	TRANS BOP
Physical Layer Options	CONN=V.35 RATE=64K IDLE=FLAGS HDW FLOW CTRL=ON	CONN=V.35 RATE=64K IDLE=FLAGS HDW FLOW CTRL=ON
Protocol Options	N/A	N/A
Protocol Address Table	FAR END PORT=1 DLCI=100	FAR END PORT=2 DLCI=17
Network Port		
Interface Type	NET	NET
Physical Layer Options	LOOP RATE=64K CLOCK SOURCE=SLAVE	LOOP RATE=64K CLOCK SOURCE=SLAVE
Frame Relay Options	SIGNAL TYPE=ANNEX D T391=10 N391=6 N392=3 N393=4	SIGNAL TYPE=ANNEX D T391=10 N391=6 N392=3 N393=4

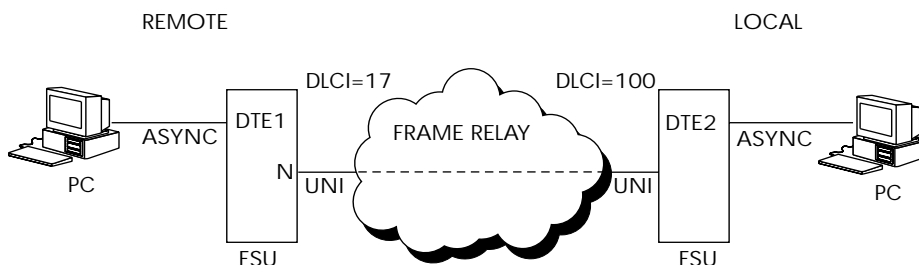

Figure 4-6
Transparent Async Application

Table 4-E
Configuration Settings for Transparent Async Application

	HOST FSU	REMOTE FSU
DTE Port 1		
Protocol	TRANS ASYNC	TRANS ASYNC
Physical Layer Options	CONN=RS232 BAUD=38.4K DATA BITS=8 PARITY=NONE STOP BITS=1 HDW FLOW CTRL=ON	CONN=RS232 BAUD=38.4K DATA BITS=8 PARITY=NONE STOP BITS=1 HDW FLOW CTRL=ON
Protocol Options	N/A	N/A
Protocol Address Table	FAR END PORT=1 DLCI=100	FAR END PORT=2 DLCI=12
Network Port		
Interface Type	NET	NET
Physical Layer Options	LOOP RATE=64K CLOCK SOURCE=SLAVE	LOOP RATE=64K CLOCK SOURCE=SLAVE
Frame Relay Options	SIGNAL TYPE=ANNEX D T391=10 N391=6 N392=3 N393=4	SIGNAL TYPE=ANNEX D T391=10 N391=6 N392=3 N393=4

Chapter 5

Configuration Overview

LOCAL AND REMOTE CONFIGURATION

The FSU can be configured locally or, when using the VT 100 interface, communications can be established so a local FSU can configure a remote FSU. See the chapter *Operation* for information on selecting Local or Remote operation.

The Configuration menu (Figure 5-1) consists of submenus relating to specific interfaces or functions of the FSU requiring setup:

- DTE Port 1
- DTE Port 2
- Network Port
- Control (front panel only)
- IP Routing
- System Configuration



Configure the Network Port before the DTE Ports. Selections made will affect the choices available for the DTE ports.



When configuring DTE port 1 or 2, select the Protocol first. This selection determines which parameters will be available for the Physical Layer Options, Protocol Options, and Protocol Address Table.

The FSU contains a default set of configuration options stored in read-only memory (see the appendix *Default Configuration Profile*). The unit is shipped from the factory with this profile loaded into the current (nonvolatile configuration) memory. If this profile matches requirements for the system, then no additional configuration is required to put the unit into service. If the profile does not match system requirements, it can be modified. When the profile is modified, it is stored in the current (nonvolatile configuration) memory. The FSU is then configured with that profile every time power is turned on.

For detailed information on configuration see the chapters *DTE Port Configuration*, *Network Port Configuration*, *IP Routing*, and *System Configuration*.

Configuration menus are shown in Figures 5-2 (for the Front Panel) and 5-3 (for the VT 100 terminal).

```
ADTRAN FSU CONFIG MENU                                LOCAL

1 DTE PORT 1
2 DTE PORT 2
3 NETWORK PORT
4 IP ROUTING
5 UNIT CONFIG

-----

ESC TO EXIT  ENTER SELECTION :_
```

Figure 5-1
VT 100 Configuration Menu

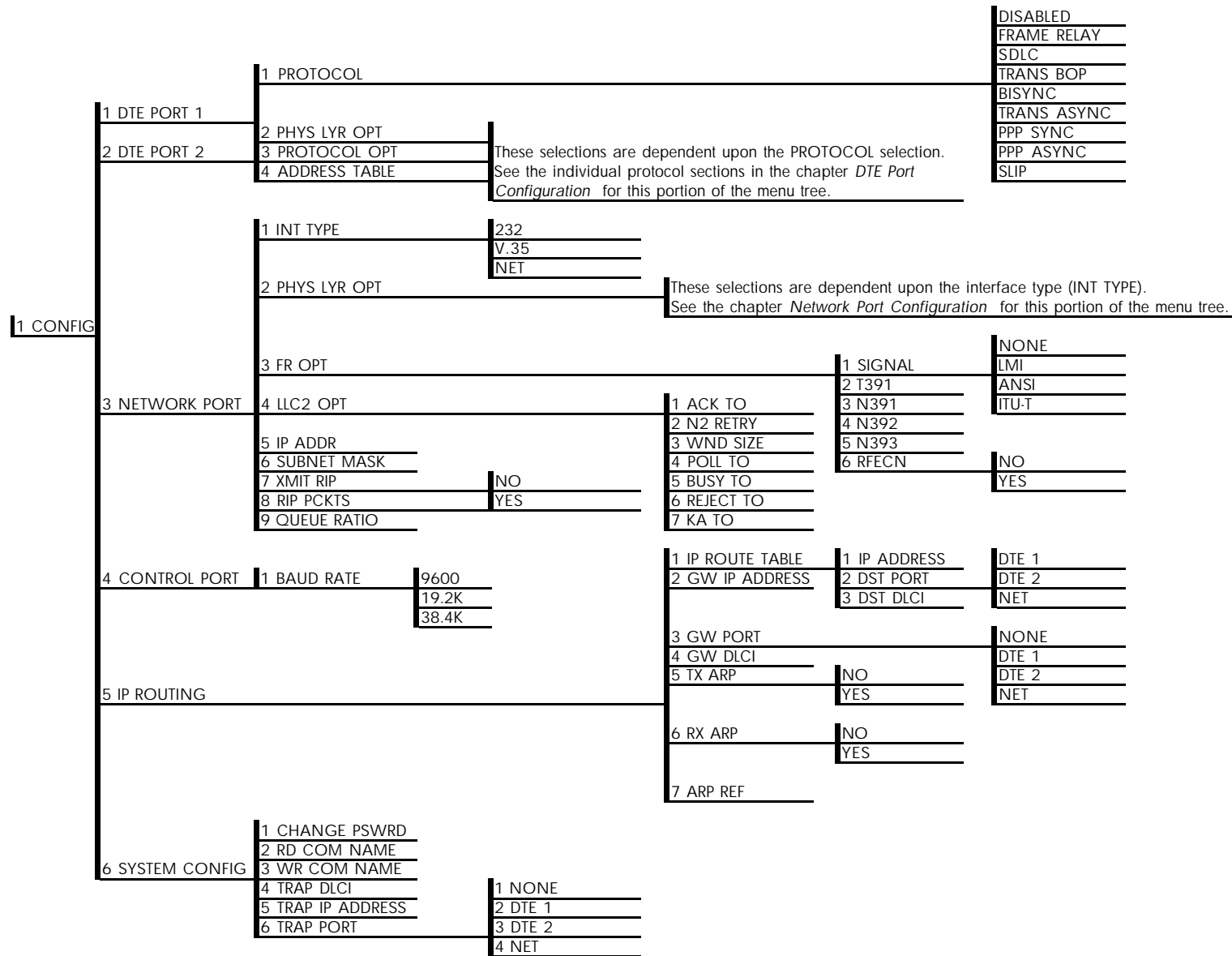

Figure 5-2
Front Panel Configuration Menu Tree

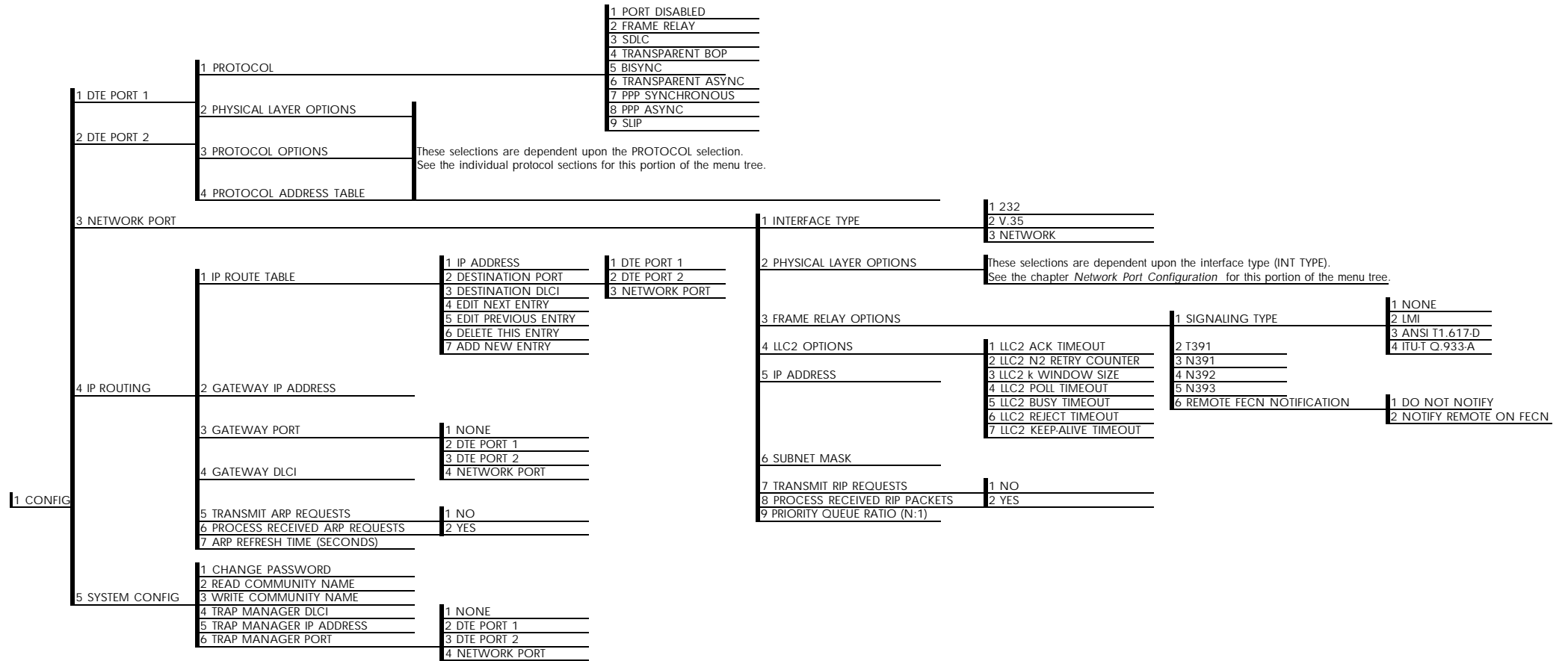

Figure 5-3
VT 100 Configuration Menu Tree

Chapter 6

DTE Port Configuration

Configure the protocol, physical layer options, protocol options, and protocol address table for the two DTE ports located on the rear of the FSU by selecting DTE PORT 1 or DTE PORT 2 from the Configuration menu. Figures 6-1 illustrates the VT 100 configuration menu for DTE Port 1.



Configure the Network Port before the DTE Ports. Selections made will affect the choices available for the DTE ports.

```
DTE PORT 1                ADTRAN FSU PORT CONFIG MENU                LOCAL
1  PROTOCOL=FRAME RELAY
2  PHYSICAL LAYER OPTIONS
3  PROTOCOL OPTIONS
4  PROTOCOL ADDRESS TABLE

-----

ESC TO EXIT  ENTER SELECTION : _
```

Figure 6-1
VT 100 Port Configuration Menu

When configuring the DTE ports, select the protocol first. This selection determines which parameters will be available in the other three categories (Physical Layer Options, Protocol Options, and Protocol Address Table). See Figure 6-2 for the menu tree leading to the protocol selection. Definitions for each choice follow, categorized by the selected protocol.



In this chapter, the VT 100 selections are listed first followed by the Front Panel selections (if the names differ).

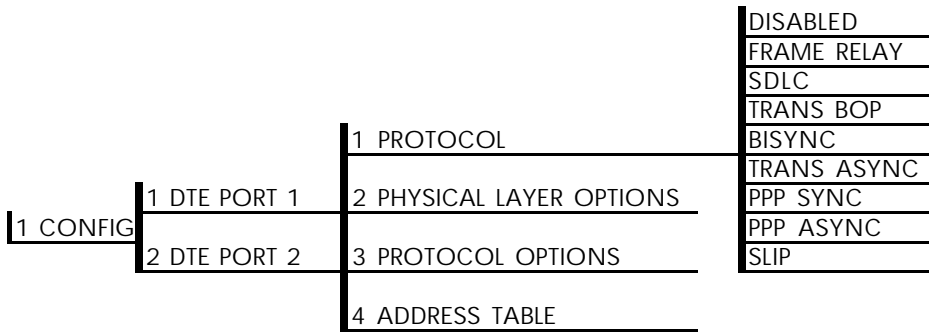

Figure 6-2
Front Panel Protocol Menu Tree

Port Disabled Protocol (DISABLED)

Follow the menu tree shown in Figure 6-3 to disable the DTE port protocol. If only one of the DTE ports is in use, select PORT DISABLED for the unused port.

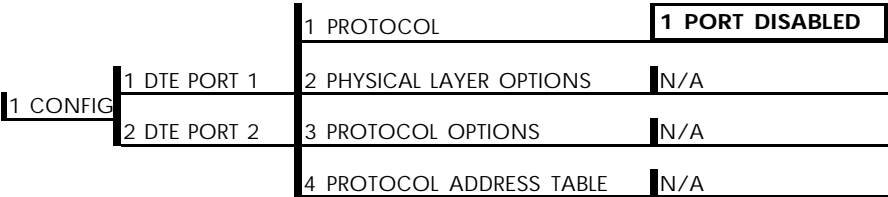

Figure 6-3
Port Disabled Menu Tree

Physical Layer Options

Physical layer options are not available when the port is disabled.

Protocol Options

Protocol options are not available when the port is disabled.

Protocol Address Table (ADDRESS TABLE)

Address table options are not available when the port is disabled.

Frame Relay Protocol

The frame relay protocol is a synchronous protocol used to concentrate two different devices into a common frame relay link to the network. While configured for frame relay protocol, the FSU accepts frame relay frames from a router or a FRAD and routes to/from the network port based on the DLCI address. The address can be modified or preserved from the DTE and network side based on the frame relay address table. FECN, BECN, DE, and C/R states are not changed as frames are transferred between the DTE and the network ports. The menu tree in Figure 6-4 shows the choices available when the frame relay protocol is selected.

Physical Layer Options

Interface Type (CONN)

Select the connector type for the DTE interface. The choices are V.35 and RS-232. See the appendix *Pinouts* for the connector pin assignments.

Synchronous Bit Rate (RATE)

Select the operating speed of the DTE interface. The selections are 2400, 4800, and 9600 bps and 19.2, 38.4, 56, 64, 112, 128, 168, 192, 224, 256, 280, 320, 384, 448, and 512 kbps.



Speed selections made for the Network Port affect the choices available for the DTE ports.

Synchronous Idle Method (IDLE)

Enable the FSU to transmit flags or all ones. When operating the frame relay protocol, configure this option to transmit flags.

Hardware Flow Control (HDW FLOW CTRL)

When enabled, the FSU varies the transmit clock rate to temporarily limit the transmit data rate to the FSU.

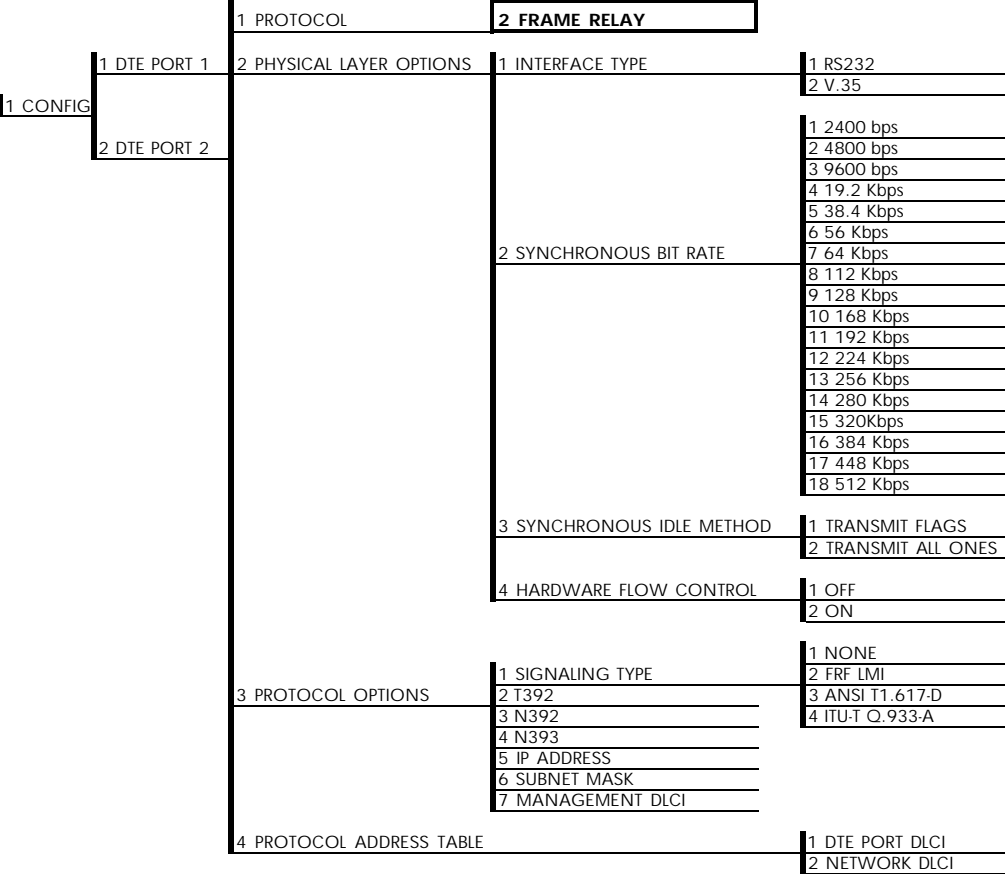

Figure 6-4
Frame Relay Protocol Menu Tree

Protocol Options

Signaling Type (SIGNAL)

Set the signaling type for the DTE port to match the signaling type of the connected DTE device. Choices are none, FRF LMI, ANSI T1.617-D, and ITU-T Q.933-A. If none is chosen, the signaling state for the DTE port is always up.

T392

Set the timeout between polling intervals. This parameter needs to be a few seconds longer than the T391 setting of the attached frame relay device.

N392 and N393

These parameters define the error threshold for the UNI formed by the FSU DTE port and the attached frame relay device. If the error threshold is met, the signaling state status is changed to down, which indicates a service-affecting condition. This condition is cleared once N393 consecutive error-free events are received. N392 defines the number of errors required in a given event window, while N393 defines the number of polling events in each window.

For example:

If N392=3 and N393=4, then if three errors occur within any four events the interface is determined inactive.

The status of the connection can be viewed in the Status menu under DTE Port Signaling State. The status will return to active once the threshold is no longer exceeded.

Guidelines for Configuring IP Addr, Subnet Mask, and Mng DLCI

If the attached router or FRAD is used to route SNMP/telnet frames to the FSU, set the Management DLCI to a unique value that identifies the virtual circuit between the router/FRAD and the FSU. The router/FRAD must also be configured to route the FSU IP address to this DLCI. The IP address and subnet mask for the DTE port must also be set.

Setting the IP address to 0.0.0.0 and setting the Mng DLCI to a value not used by the attached frame relay device disables this feature.

IP Address (IP ADDR)

Enter the FSU IP address. Each port capable of carrying IP traffic has its own unique IP address. See the previous section, *Guidelines for Configuring IP Addr, Subnet Mask, and Mng DLCI*, for more information.

IP Subnet Mask

Enter the subnet number assigned to the network formed by the FSU and the other FRAD/routers across the frame relay network. See the section, *Guidelines for Configuring IP Addr, IP Subnet Mask, and Mng DLCI*, for more information.

Management DLCI (MNG DLCI)

Enter the management data link connection identifier. The Management DLCI is a special DLCI used between the attached DTE device and the FSU to carry SNMP and telnet packets to/from the FSU on the DTE port. See the section, *Guidelines for Configuring IP Addr, Subnet Mask, and Mng DLCI*, for more information.

Protocol Address Table**DTE Port DLCI (PRT DLCI)**

Enter the DTE port DLCI into the Protocol Address Table, mapping it to the corresponding Network DLCI. If address translation is not required, set to the value of the corresponding network DLCI element.

Network DLCI (NET DLCI)

Enter the network port DLCI into the Protocol Address Table, mapping it to the corresponding DTE Port DLCI. This element should contain DLCI addresses obtained from the service provider.

Edit Next Entry (NEXT key on front panel)

Edit the next entry in the address table.

Edit Previous Entry (PREV key on front panel)

Edit the previous entry in the address table.

Delete This Entry (DEL key on front panel)

Delete the current entry in the address table.

Add New Entry (ADD key on front panel)

Add a new entry to the address table.



There should be one entry for every virtual circuit on the frame relay DTE port.

SDLC Protocol

SDLC is a synchronous, bit-oriented, full-duplex, Layer 2 protocol used to connect SDLC devices to a frame relay network. At Layer 2, SNA networks use SDLC between FEPs (front-end processors) and cluster controllers. This protocol selection provides Logical Link Control Type 2 (LLC2). LLC2 defines the data link frame header and supports the multiplexing of one or more data links to/from separate service access points (SAPs). Type 2 provides acknowledged, connection-oriented service. See Figure 6-5.

The PU (physical unit) address, LLC2 SSAP, LLC2 DSAP, and outgoing DLCI are used to set up an end-to-end SDLC session for each PU in the network. The PU address elements should match the address of each controller address attached to the port. The DLCI determines the path across the frame relay network and is given by the service provider. The SSAP/DSAP pairs are user-defined but should match between two FSUs for each SDLC session.



All PU addresses for a port must be unique, but it is not necessary that they match the PU address at the remote end. The SSAP/DSAP/DLCI is used to make the connection across the frame relay network.

Physical Layer Options

Interface Type (CONN)

Select the connector type for the DTE interface. The choices are V.35 and RS-232.

Synchronous Bit Rate (RATE)

Select the operating speed of the DTE interface. The selections are 2400, 4800, and 9600 bps and 19.2, 38.4, 56, 64, 112, 128, 168, 192, 224, 256, 280, 320, 384, 448, and 512 kbps.



Speed selections made for the Network Port affect the choices available for the DTE ports.

Synchronous Idle Method (IDLE)

Enable the FSU to transmit flags or all ones. When configured for the SDLC protocol, all ones is the recommended setting.

Hardware Flow Control (HDW FLOW CTRL)

When configured for the SDLC protocol, this parameter is always enabled. The FSU issues RNR (receive not ready) commands to the attached PU, temporarily disabling transmit data to the FSU.

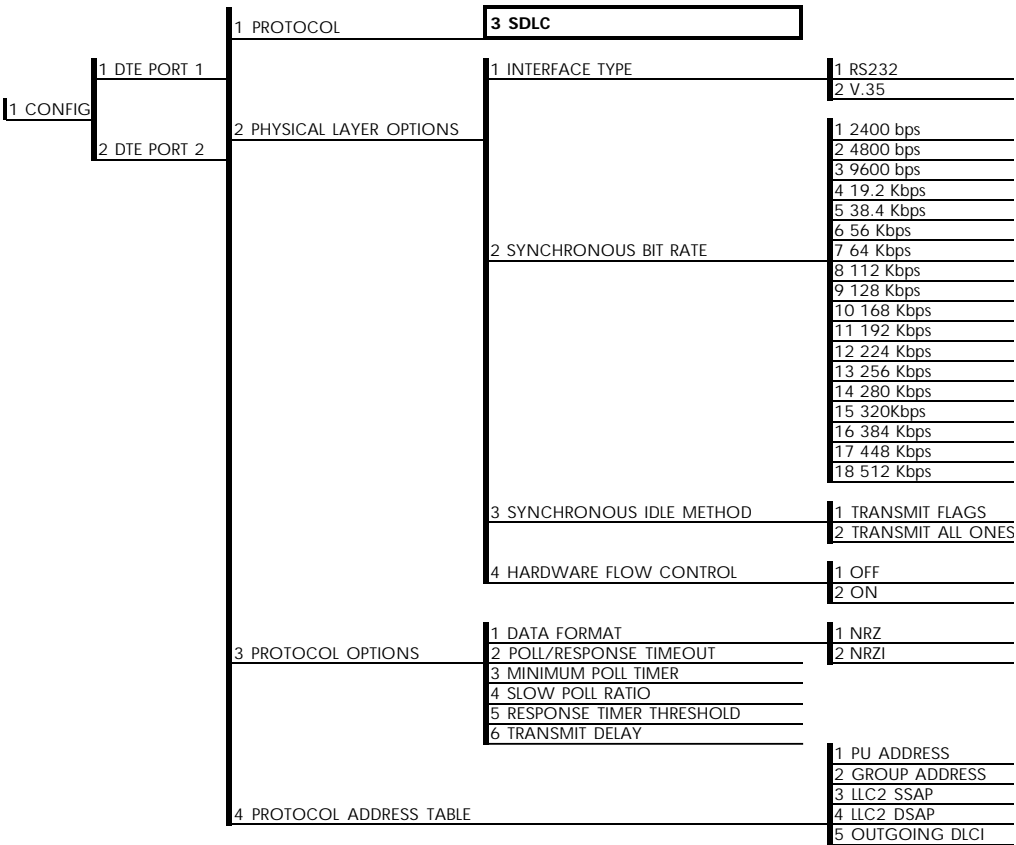

Figure 6-5
SDLC Protocol Menu Tree

Protocol Options

Data Format (FORMAT)

Set the data format to match the attached controller or FEP line coding. The choices are non-return-to zero (NRZ) and non-return-to-zero inverted (NRZI).



When using NRZI format, the FSU does not derive timing from the receive data input.

Poll/Response Timeout (TIMEOUT)

Set the amount of time the FSU waits for a poll response before issuing another poll.

Minimum Poll Timer

This parameter defines the minimum time (ms) between consecutive polls to a given PU assigned to the DTE port.

Slow Poll Ratio (POLL RAT)

Determine how often devices on the Slow Poll list are polled. This list is automatically managed based on poll timeouts. Initially, all PUs are on the Normal list. When a PU times out a fixed number of times, it is moved to the Slow Poll list. A PU remains on this list until it responds properly to a poll.

The number entered is the number of times PUs on the Normal list are polled before PUs on the Slow Poll list are polled. Enter 1 to disable this option.

Response Timer Threshold (THRESHOLD)

Set the maximum number of response timeouts allowed before a session is terminated.

Transmit Delay (DELAY)

Set the minimum time between transmission frames.

Protocol Address Table**PU Address (PU ADDR)**

Enter the physical unit address of each SDLC device you wish to connect to the FSU.

Group Address (GROUP ADDR)

Enter the address used for group polling. With this address the host can poll the FSU for information on all units connected to the FSU. This address should match the host's group address. Set this entry to 0 to disable group polling for the DTE port.

LLC2 SSAP (LLC SSAP)

Defines a point-to-point connection on the network. For an SDLC connection, the SSAP of one FSU should match the DSAP on the other FSU. The value of this parameter must be in increments of four beginning with 04.

LLC2 DSAP (LLC DSAP)

Defines a point-to-point connection on the network. For an SDLC connection, the DSAP of one FSU should match the SSAP on the other FSU. The value of this parameter must be in increments of four beginning with 04. See the section *SNA/SDLC with Local Spoofing* in the chapter *Applications* for a configuration example which demonstrates the SSAP and DSAP arrangement.

Outgoing DLCI (OUT DLCI)

Enter the DLCI address that identifies the virtual circuit used to make the SDLC connection.

Edit Next Entry (NEXT on front panel)

Edit the next entry in the address table.

Edit Previous Entry (PREV on front panel)

Edit the previous entry in the address table.

Delete This Entry (DEL on front panel)

Delete the current entry in the address table.

Add New Entry (ADD on front panel)

Add a new entry to the address table.

Transparent BOP (TRANS BOP)

Transparent BOP is a synchronous mode which can accept any HDLC-like protocol as input. This setting allows the FSU to connect to devices even if the FSU does not understand their protocol's addressing and controlling techniques. The FSU becomes transparent to the data link layer protocol and provides end-to-end connectivity between two HDLC-like devices. See Figure 6-6 for the Transparent BOP menu tree.

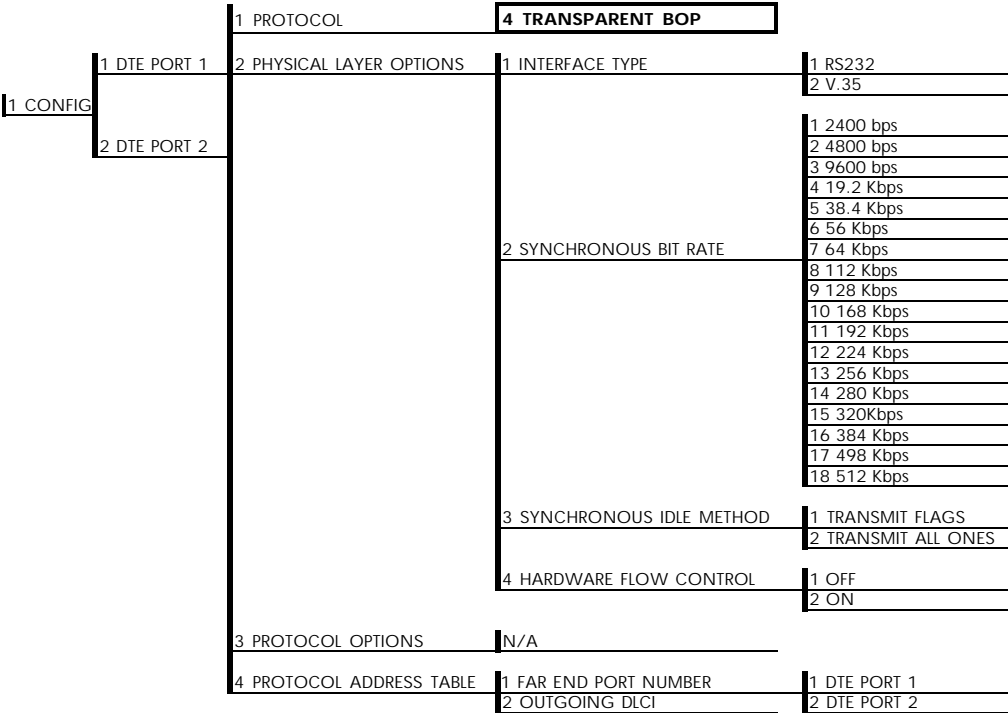

Figure 6-6
Transparent BOP Menu Tree

Physical Layer Options

Interface Type (CONN)

Select the connector type for the DTE interface. The choices are V.35 and RS-232.

Synchronous Bit Rate (RATE)

Select the operating speed of the DTE interface. The selections are 2400, 4800, and 9600 bps and 19.2, 38.4, 56, 64, 112, 128, 168, 192, 224, 256, 280, 320, 384, 448, and 512 kbps.



Speed selections made for the Network Port affect the choices available for the DTE ports.

Synchronous Idle Method (IDLE)

Enable the FSU to transmit flags or all ones (flags are recommended).

Hardware Flow Control (HDW FLOW CTRL)

When enabled, the FSU varies the transmit clock rate to temporarily limit the transmit data rate to the FSU.

Protocol Options

Protocol options are not available when the Transparent BOP protocol is enabled.

Protocol Address Table

Far End Port Number (FE PORT)

Enter the remote FSU port number that the remote HDLC device is connected to.

Outgoing DLCI (OUT DLCI)

Enter the DLCI address that indicates the virtual circuit used to connect with the remote FSU.

Bisync Protocol

The Bisync protocol option enables the FSU to connect IBM 2780/3780 bisync controllers to the host across frame relay. Both point-to-point and multi-point configurations are supported.

The FSU can decode both ASCII and EBCDIC character sets and support CRC16, parity, VRC, and LRC error checking methods. See Figure 6-7 for the Bisync protocol menu tree.

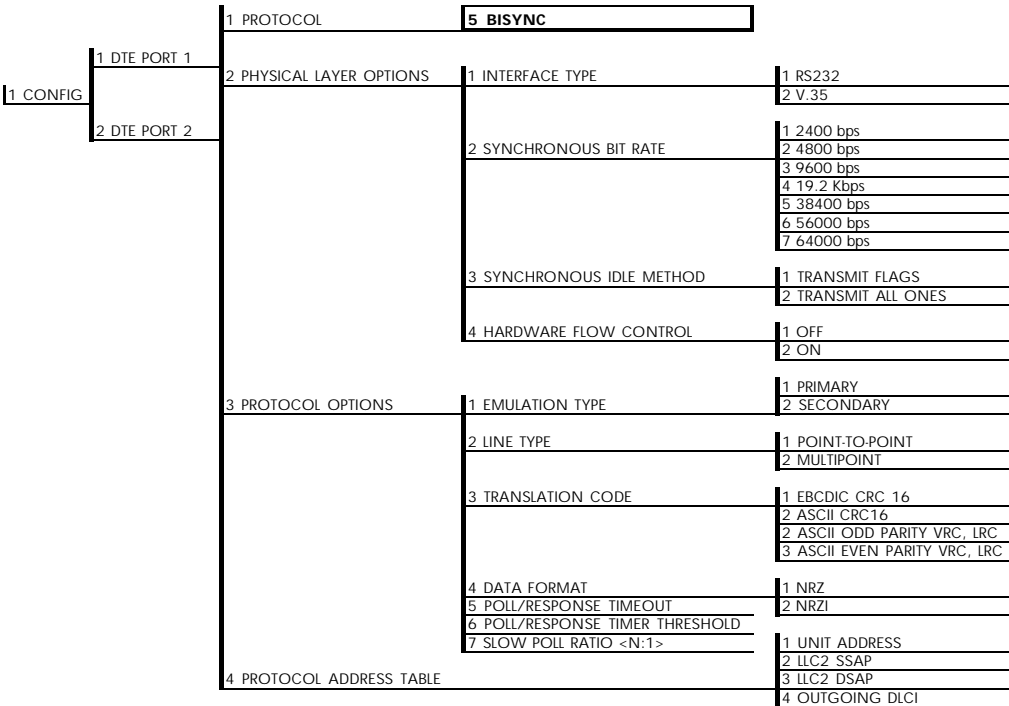

Figure 6-7
Bisync Protocol Menu Tree

Physical Layer Options

Interface Type (CONN)

Select the connector type for the DTE interface. The choices are V.35 and RS-232.

Synchronous Bit Rate (RATE)

Select the operating speed of the DTE interface. These selections are dependent upon the Network Port speed.



Speed selections made for the Network Port affect the choices available for the DTE ports.

Synchronous Idle Method (IDLE)

Enable the FSU to transmit flags or all ones.

Hardware Flow Control (HDW FLOW CTRL)

When configured for the Bisync protocol, this parameter is always enabled. The FSU uses commands within the bisync protocol to temporarily disable transmit data to the FSU.

Protocol Options

Emulation Type (EMUL TYPE)

For multi-point configurations, this entry defines primary or secondary emulation. Set the FSU connected to the host to secondary and the FSU connected to the 2780/3780 controller to primary.

Line Type (LINE)

Select a point-to-point or multi-point line type.

Translation Code

Define the character set and error checking algorithm to use. The choices are EBCDIC CRC16, ASCII CRC16, ASCII odd parity VRC/LRC, and ASCII even parity VRC/LRC.

Data Format (FORMAT)

Set the data format used by your equipment. The choices are non-return-to zero (NRZ) and non-return-to-zero inverted (NRZI).

Poll/Response Timeout (TIMEOUT)

For multi-point configurations, set the amount of time the FSU waits for a poll response before issuing another poll.

Poll/Response Timer Threshold (THRESHOLD)

For multi-point configurations, set the maximum number of response timeouts allowed before a session is terminated.

Slow Poll Ratio <N:1> (POLL RAT)

Determine how often devices on the Slow Poll List are polled. This list is automatically managed based on poll timeouts. Initially, all controllers are on the Normal list. When a controller times out a fixed number of times, it is moved to the Slow Poll list. A controller remains on this list until it responds properly to a poll.

The number entered is the number of times controllers on the Normal list are polled before controllers on the Slow Poll list are polled. Enter 1 to disable this option.

Protocol Address Table**Unit Address (UNIT ADDR)**

For a multi-point connection, enter the unit address used for specific unit identification. The address may consist of a maximum of seven alphanumeric characters. There must be one alphabetic character for this parameter so the FSU can use the upper case version for the port address and the lower case version for the select address.

LLC2 SSAP (LLC SSAP)

Defines a point-to-point connection on the network. For each bisync SDLC connection, the SSAP of one FSU should match the DSAP on the other FSU.

LLC2 DSAP (LLC DSAP)

Define a point-to-point connection on the network. For each bisync SDLC connection, the DSAP of one FSU should match the SSAP on the other FSU. See the section *SNA/SDLC with Local Spoofing* in the chapter *Applications* for a configuration example which demonstrates the SSAP and DSAP arrangement.

Outgoing DLCI (OUT DLCI)

Enter the DLCI address used to connect with the remote device across the frame relay network.

Edit Next Entry (NEXT key on front panel)

Edit the next entry in the address table.

Edit Previous Entry (PREV key on front panel)

Edit the previous entry in the address table.

Delete This Entry (DEL key on front panel)

Delete the current entry in the address table.

Add New Entry (ADD key on front panel)

Add a new entry to the address table.

Transparent Async Protocol (TRANS ASYNC)

Transparent Async protocol frames up async characters to transport across a frame relay network. This protocol is used when the device connected to the FSU is an async device such as a terminal or PC. See Figure 6-8 for the Transparent Async menu tree.

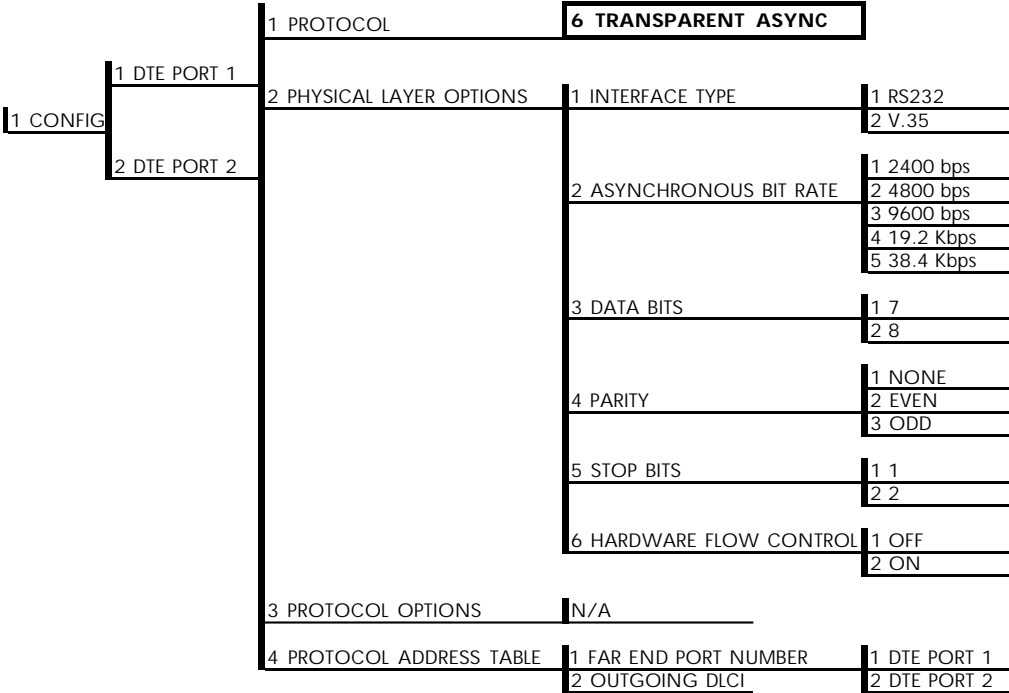

Figure 6-8
Transparent Async Protocol Menu Tree

The FSU buffers async characters from the DTE device until two idle characters or 100 characters are received. A frame relay synchronous frame is constructed containing the data content of each character. Frame relay frames received on the network containing transparent async data are transmitted to the attached device with the character format set under the DTE port physical layer options.



No control lead status or break characters are transmitted across the frame relay network.

Physical Layer Options

Interface Type (CONN)

Select the connector type for the DTE interface. The choices are V.35 and RS-232.

Asynchronous Bit Rate (BIT RATE)

Select the operating speed to match the DTE device connected to the FSU. The selections are 2400 bps, 4800 bps, 9600 bps, 19.2 kbps, and 38.4 kbps.

Data Bits

Select the byte length to match the DTE device connected to the FSU. The choices are 7 and 8.

Parity

Select even, odd, or no parity information. Set to match the DTE device connected to the FSU.

Stop Bits

Select one or two stop bits. Set to match the DTE device connected to the FSU.

Hardware Flow Control (HDW FLOW CTRL)

When enabled, the FSU uses CTS to temporarily disable transmit data to the FSU.

Protocol Options

Protocol options are not available when the Transparent Async protocol is selected.

Protocol Address Table

Far End Port Number (FE PORT)

Enter the remote FSU port number that the remote device is connected to.

Outgoing DLCI (OUT DLCI)

Enter the DLCI address that identifies the virtual circuit used to connect with the remote FSU.

PPP Synchronous Protocol (PPP SYNC)

PPP Synchronous protocol provides a PPP device access to the frame relay network and also routes IP traffic from the network to the PPP device. See Figure 6-9 for the PPP synchronous menu tree.

Routing

Routing tables are formed through a combination of RIP and static route entries. If RIP is used, routing tables are generated dynamically. With static routing, the user is able to force relationships. Static route tables are configured through the IP Routing selection in the CONFIG menu.



*Static routing requires additional configuration (see the chapter **IP Routing** for more information).*



The port set for PPP Synchronous protocol routes and supports IP traffic only.

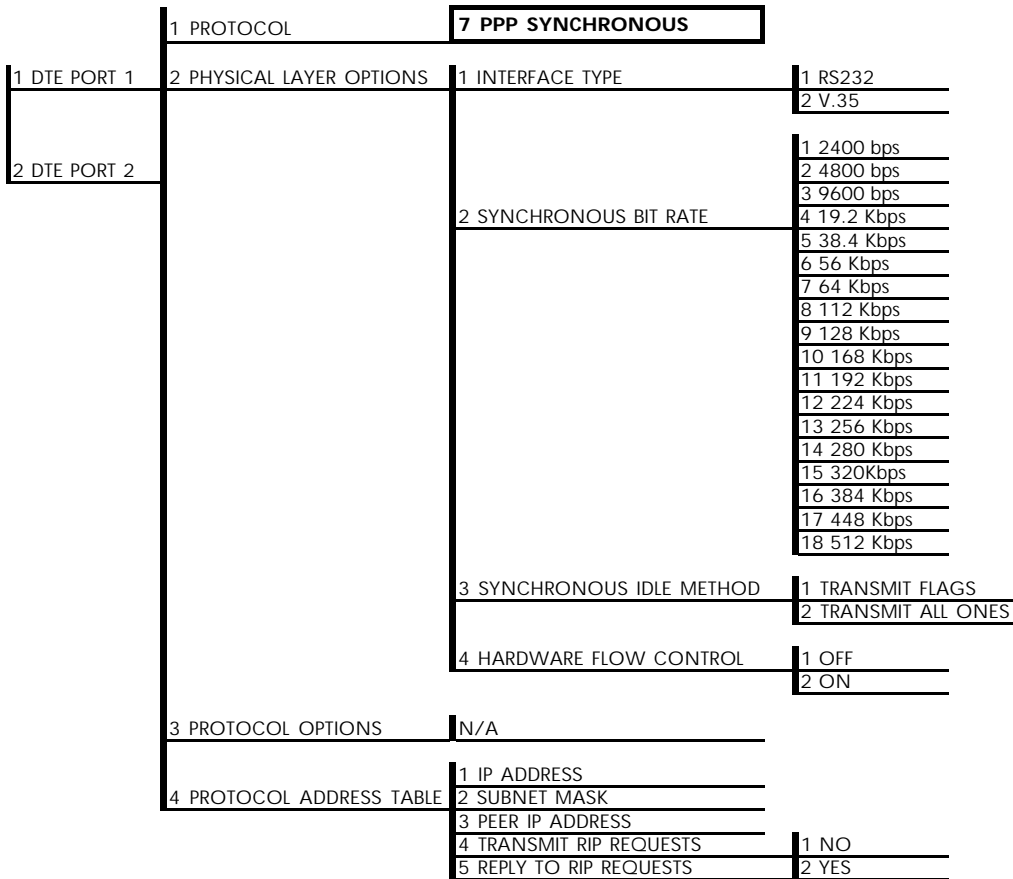

Figure 6-9
PPP Synchronous Protocol Menu Tree

Physical Layer Options

Interface Type (CONN)

Select the connector type for the DTE interface. The choices are V.35 and RS-232.

Synchronous Bit Rate (RATE)

Select the operating speed of the DTE interface. The selections are 2400, 4800, and 9600 bps and 19.2, 38.4, 56, 64, 112, 128, 168, 192, 224, 256, 280, 320, 384, 448, and 512 kbps.



Speed selections made for the Network Port affect the choices available for the DTE ports.

Synchronous Idle Method (IDLE)

Enable the FSU to transmit flags or all ones.

Hardware Flow Control (HDW FLOW CTRL)

When enabled, the FSU varies the transmit clock rate to temporarily limit the transmit data rate to the FSU.

Protocol Options

Protocol options are not available when the PPP Synchronous protocol is enabled.

Protocol Address Table**IP Address (IP ADDR)**

Enter the internet protocol (IP) address assigned to the FSU for the DTE port.

Subnet Mask

Enter the subnet number assigned to the network formed by the FSU and the Peer PPP station.

Peer IP Address (PEER IP)

Enter the IP address of the attached PPP device.

Transmit RIP Requests (TX RIP)

Enable or disable the FSU's transmission of routing information protocol (RIP) messages. RIP broadcasts occur in 60 second intervals, advertising network addresses to the Peer PPP device. Routing tables are generated from these broadcasts.

Reply to RIP Requests (RIP REPLY)

Enable or disable the FSU's reply to the request from the Peer PPP device to issue RIP messages.

PPP Async Protocol

The PPP Async Protocol functions the same as the PPP Synchronous Protocol except for the port is in async format, connected to an async device. Special control characters are used to determine frame boundaries for the async channel. See Figure 6-10 for the PPP Asynchronous menu tree.

Routing

Routing tables are formed through a combination of RIP and static route entries. If RIP is used, all routing tables are generated dynamically. With static routing, the user is able to force relationships. Static route tables are configured through the IP Routing selection in the CONFIG menu.



*Static routing requires additional configuration (see the chapter **IP Routing** for more information).*

Physical Layer Options

Interface Type (CONN)

Select the connector type for the DTE interface. The choices are V.35 and RS-232.

Asynchronous Bit Rate (BIT RATE)

Select the operating speed of the DTE interface to match the connected device. The selections are 2400 bps, 4800 bps, 9600 bps, 19.2 kbps, and 38.3 kbps.

Data Bits

Select the byte length to match the connected asynchronous device. The choices are 7 and 8.

Parity

Select even, odd, or no parity information. Set to match the connected asynchronous device.

Stop Bits

Select one or two stop bits. Set to match the connected asynchronous device.

Hardware Flow Control (HDW FLOW CTRL)

When enabled, the FSU uses CTS to temporarily disable transmit data to the FSU.

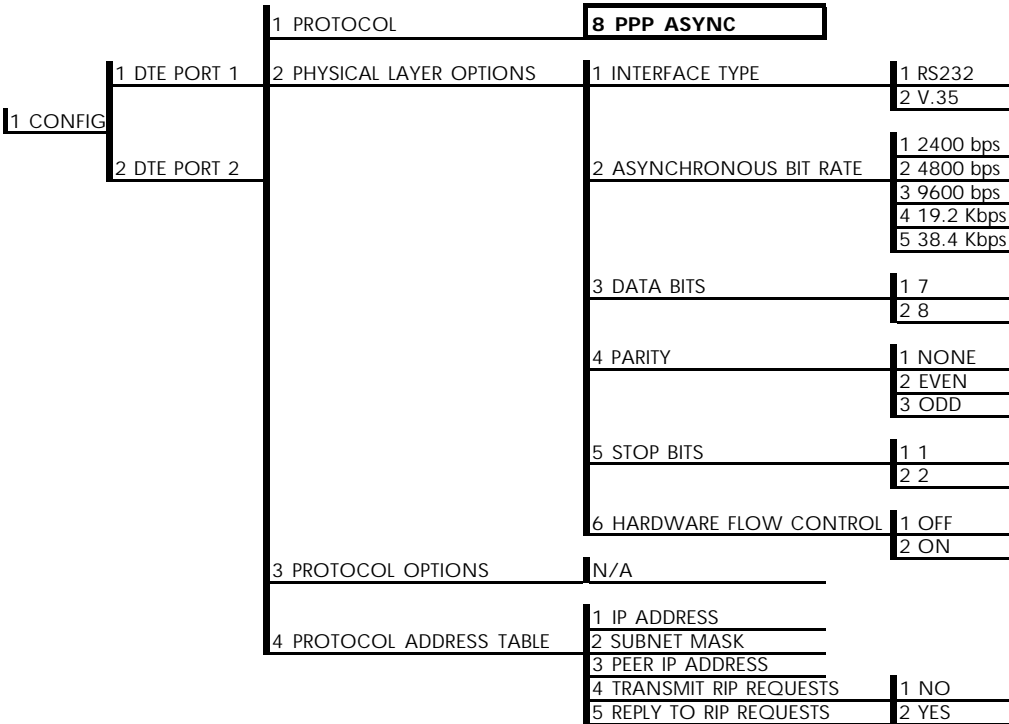

Figure 6-10
PPP Asynchronous Protocol Menu Tree

Protocol Options

Protocol options are not available when the PPP Asynchronous protocol is enabled.

Protocol Address Table

IP Address (IP ADDR)

Enter the internet protocol (IP) address of the FSU DTE port.

Subnet Mask

Enter the subnet number of the network formed by the FSU and the Peer PPP station.

Peer IP Address (PEER IP)

Enter the IP address of the attached PPP device.

Transmit RIP Requests (TX RIP)

Enable or disable the FSU's transmission of routing information protocol (RIP) messages. RIP broadcasts occur in 60 second intervals, advertising network addresses to the Peer PPP device. Routing tables are generated from these broadcasts.

Reply to RIP Requests (RIP REPLY)

Enable or disable the FSU's reply to the request from the Peer PPP device to issue RIP messages.

Slip Protocol

The Slip Protocol is an asynchronous protocol which encapsulates and routes IP traffic to and from a SLIP device. Special control characters are used to define frame boundaries. See Figure 6-11 for the Slip menu tree.

Routing

Routing tables are formed through a combination of RIP and static route entries. If RIP is used, all routing tables are generated dynamically. With static routing, the user is able to force relationships. Static route tables are configured through the IP Routing selection in the CONFIG menu.



*Static routing requires additional configuration (see the chapter **IP Routing** for more information).*

Physical Layer Options

Interface Type (CONN)

Select the connector type for the DTE interface. The choices are V.35 and RS-232.

Asynchronous Bit Rate (BIT RATE)

Set the operating speed of the DTE interface to match the connected device. The selections are 2400 bps, 4800 bps, 9600 bps, 19.2 kbps, and 38.4 kbps.

Data Bits

Set the byte length to match the connected asynchronous device. The choices are 7 and 8.

Parity

Select even, odd, or no parity information. Set to match the connected asynchronous device.

Stop Bits

Select one or two stop bits. Set to match the connected asynchronous device.

Hardware Flow Control (HDW FLOW CTRL)

When enabled, the FSU uses CTS to temporarily disable transmit data to the FSU.

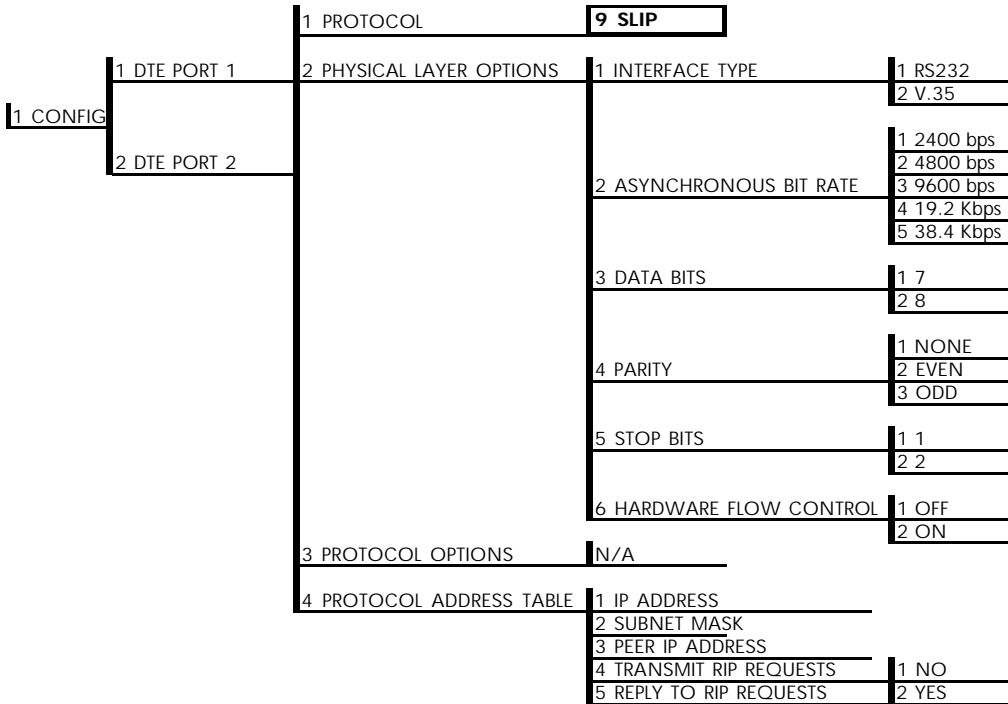

Figure 6-11
Slip Protocol Menu Tree

Protocol Options

Protocol options are not available when the SLIP protocol is enabled.

Protocol Address Table

IP Address (IP ADDR)

Enter the internet protocol (IP) address of the FSU DTE port.

Subnet Mask

Enter the subnet number of the network formed by the FSU and the Peer SLIP station.

Peer IP Address (PEER IP)

Enter the IP address of the attached SLIP device.

Transmit RIP Requests (TX RIP)

Enable or disable the FSU's transmission of routing information protocol (RIP) messages. RIP broadcasts occur in 60 second intervals, advertising network addresses to the Peer SLIP device. Routing tables are generated from these broadcasts.

Reply to RIP Requests (RIP REPLY)

Enable or disable the FSU's reply to the request from the Peer SLIP device to issue RIP messages.

Chapter 7

Configuring the Network Port

NETWORK PORT

Access the Network Port menus by selecting Network Port from the Configuration menu. See the menu tree in Figure 7-1. The network port is always used in frame relay protocol configurations. The network port terminates the user end of the frame relay UNI interface. The FSU supports three standard PVC signaling formats: LMI, ANSI T1.617-D, and ITU Q.933-A. The selected signaling format is used to poll the network end of the UNI interface and retrieve virtual circuit information. Optionally the polling process can be disabled.

User data is encapsulated into standard frame relay formatted frames using two methods. FRF 3.1 IA procedures are used for IP and LLC2 protocols while a proprietary method is used for transparent protocol mode. Virtual circuit sharing is allowed for both methods.



Configure the Network Port before the DTE Ports. Selections made will affect the choices available for the DTE ports.

Connection

Connection is made through the internal DDS 56/64 DSU (if installed). If this option is not installed, use an external DDS or fractional T1 (up to 512 kbps) DSU.



When connecting to an external DSU, the FSU emulates an externally timed DTE interface connected directly to the DCE interface of the external device. Therefore, the connection between the FSU and the DSU is a direct connection.

1 CONFIG	3 NETWORK PORT	1 INTERFACE TYPE	1 RS232		
			2 V.35		
			3 NETWORK		
	1 DTE PORT 1	2 DTE PORT 2	2 PHYSICAL LAYER OPTIONS	1 LOOP RATE (available when NETWORK interface type is selected)	1 56K
					2 64K
	4 IP ROUTING	5 SYSTEM CONFIG	3 NETWORK PORT	2 CLOCK SOURCE (available when NETWORK interface type is selected)	1 MASTER
					2 FROM NETWORK
	4 IP ROUTING	5 SYSTEM CONFIG	3 NETWORK PORT	1 NETWORK BIT RATE (available when RS232 or V.35 interface type is selected)	56K and 64K available for RS232 and V.35 interfaces.
					Additional rates of 112K through 512K available for V.35 interface.
4 IP ROUTING	5 SYSTEM CONFIG	3 NETWORK PORT	1 SIGNALING TYPE	1 NONE	
			3 FRAME RELAY OPTIONS	2 LMI	
4 IP ROUTING	5 SYSTEM CONFIG	3 NETWORK PORT	2 I391	3 ANSI T1.617-D	
				4 ITU-T Q.933-A	
4 IP ROUTING	5 SYSTEM CONFIG	3 NETWORK PORT	3 N391		
				4 N392	
4 IP ROUTING	5 SYSTEM CONFIG	3 NETWORK PORT	4 N392		
				5 N393	
4 IP ROUTING	5 SYSTEM CONFIG	3 NETWORK PORT	5 N393		
				6 REMOTE FECN NOTIFICATION	
4 IP ROUTING	5 SYSTEM CONFIG	3 NETWORK PORT		1 DO NOT NOTIFY	
				2 NOTIFY REMOTE ON FECN	
4 IP ROUTING	5 SYSTEM CONFIG	3 NETWORK PORT	4 LLC2 OPTIONS	1 LLC2 ACK TIMEOUT	
				2 LLC2 N2 RETRY COUNTER	
4 IP ROUTING	5 SYSTEM CONFIG	3 NETWORK PORT	5 IP ADDRESS	3 LLC2 k WINDOW SIZE	
				4 LLC2 POLL TIMEOUT	
4 IP ROUTING	5 SYSTEM CONFIG	3 NETWORK PORT	6 SUBNET MASK	5 LLC2 BUSY TIMEOUT	
				6 LLC2 REJECT TIMEOUT	
4 IP ROUTING	5 SYSTEM CONFIG	3 NETWORK PORT		7 LLC2 KEEP-ALIVE TIMEOUT	
4 IP ROUTING	5 SYSTEM CONFIG	3 NETWORK PORT	7 TRANSMIT RIP REQUESTS	1 NO	
				2 YES	
4 IP ROUTING	5 SYSTEM CONFIG	3 NETWORK PORT	8 PROCESS RECEIVED RIP PACKETS		
				9 PRIORITY QUEUE RATIO (N:1)	

Figure 7-1
Network Port Configuration Menu Tree

When configuring from a VT 100 terminal, the screen in Figure 7-2 will appear when Network Port is selected.



In this chapter, the VT 100 selections are listed first followed by the Front Panel selections (if the names differ).

```
ADTRAN FSU NETWORK PORT CONFIG MENU LOCAL
1 INTERFACE TYPE=RS232
2 PHYSICAL LAYER OPTIONS
3 FRAME RELAY OPTIONS
4 LLC2 OPTIONS
5 IP ADDRESS=0.0.0.0
6 SUBNET MASK=0.0.0.0
7 TRANSMIT RIP REQUESTS=NO
8 PROCESS RECEIVED RIP PACKETS=NO
9 PRIORITY QUEUE RATIO (N:1)=0

-----

ESC TO EXIT  ENTER SELECTION : _
```

Figure 7-2
VT 100 Network Port Configuration Menu

Interface Type (INT TYPE)

Select the connector type for the network interface. The choices are V.35 and RS232. If the internal DSU is installed, the NET selection will appear. Select NET to operate the internal DSU.

Physical Layer Options (PHYS LYR OPT)

The following physical layer options are available when the internal DSU is selected as the interface type:

Loop Rate

Select a loop rate of either 56k or 64k.

Clock Source

Configure the FSU clocking source as either the master or slave (usually slave).

The following physical layer option is available when the selected interface type is V.35 or RS232:

Bit Rate

Select the bit rate that closely matches the clock rate supplied by the external DSU. The choices are 56k and 64k when RS232 interface type is selected. Additional choices of 112k, 128k, 168k, 192k, 224k, 256k, 280k, 320k, 384k, 448k, and 512k are available when the V.35 interface is selected.

Frame Relay Options (FR OPT)

The VT 100 screen in Figure 7-3 appears when Frame Relay Options is selected from the Network Port Configuration Menu.

```
ADTRAN FSU NETWORK PORT FRAME RELAY OPTIONS LOCAL
1 SIGNALING TYPE=NONE
2 T391=0
3 N391=0
4 N392=0
5 N393=0
6 REMOTE FECN NOTIFICATION=DO NOT NOTIFY

-----

ESC TO EXIT  ENTER SELECTION : _
```

Figure 7-3
VT 100 Network Port Frame Relay Options Menu

Signaling Type (SIGNAL)

Set the signaling type option to match the network signaling type.

T391

Set the time between polls to the frame relay network.

N391

Determine how many link integrity polls occur in between full status polls.

N392 and N393

These parameters define the error threshold for the UNI formed by the FSU network port and the frame relay switch. If the error threshold is met, the signaling state status is changed to down, which indicates a service-affecting condition. This condition is cleared once N393 consecutive error-free events are received. N392 defines the number of errors required in a given event window, while N393 defines the number of polling events in each window.

For example:

If N392=3 and N393= 4, then if three errors occur within any four events the interface is determined inactive.

The status of the connection can be viewed in the Status menu under Network Port Signaling State. The status will return to active again once the threshold is no longer exceeded.

Remote FECN Notification (RFECN)

Enable/disable the FSU to issue remote FECN (forward explicit congestion notification). This feature ensures that a frame will be generated in the reverse direction upon receiving a frame with the FECN bit enabled. This is a proprietary feature with ADTRAN FSUs and can only be used with an ADTRAN FSU on both ends of the virtual circuit.



The network service provider should recommend the values entered into the T391, N391, N392, and N393 fields.

LLC2 Options (LLC2 OPT)

The VT 100 screen in Figure 7-4 appears when LLC2 (Logical Link Control Type 2) Options is selected from the Network Port Configuration menu.

LLC2 ACK Timeout (ACK TO)

Timeout value used by the LLC2 protocol to establish the maximum time to wait for a positive acknowledgment from a remote device.

LLC2 N2 Retry Counter (N2 RETRY)

Maximum retries for actions timed by the ACK poll, busy or reflect timers. When N2 is exceeded, a reset condition occurs.

LLC2 k Window Size (WND SIZE)

Maximum number of outstanding unacknowledged data frames that the LLC2 protocol will allow.

LLC2 Poll Timeout (POLL TO)

Maximum time to wait for a response to a command having the poll bit set.

LLC2 Busy Timeout (BUSY TO)

Length of time the LLC2 protocol will wait for a remote device to clear a busy state before querying it with an RR (receiver ready) command.

LLC2 Reject Timeout (REJECT TO)

Maximum time the LLC2 protocol will wait for a reject response after issuing a reject command.

LLC2 Keep-Alive Timeout (KA TO)

Optional tool for detecting the status of an LLC2 connection.

```
ADTRAN FSU NETWORK PORT LLC2 OPTIONS LOCAL
1 LLC2 ACK TIMEOUT=0
2 LLC2 N2 RETRY COUNTER=0
3 LLC2 k WINDOW SIZE=0
4 LLC2 POLL TIMEOUT=0
5 LLC2 BUSY TIMEOUT=0
6 LLC2 REJECT TIMEOUT=0
7 LLC2 KEEP-ALIVE TIMEOUT=0
-----
ESC TO EXIT  ENTER SELECTION :_
```

Figure 7-4
VT 100 Network Port LLC2 Options Menu

Local IP Address (LOCAL IP ADDR)

Enter the internet protocol (IP) address of the FSU Network port.

Subnet Mask

Enter the subnet number of the network formed by the FSU and the other FRADs/routers across the frame relay network.

Transmit RIP Requests (XMIT RIP)

Enable or disable the FSU's transmission of routing information protocol (RIP) messages. RIP broadcasts occur in 60 second intervals, advertising network addresses to the peer routers or FRADs. Routing tables are generated from these broadcasts.

Process Received RIP Packets

Enable or disable the FSU's reply to the request from the peer routers or FRADs to issue RIP messages.

Priority Queue Ration (N:1)

Define the ratio that SDLC frames have over other protocols. SDLC protocols are processed each time the network port transmitter is serviced. Other protocols are processed every N times the SDLC protocol is processed. Set to 1 to enable equal priority.

Chapter 8

IP Routing

IP ROUTING WITH THE FSU

The FSU contains an IP router function to resolve paths for IP packets received. This function is used regardless of encapsulation protocol and port received from.

The heart of the routing system is a routing table which can be generated manually, automatically, or a combination of the two. Manual entry is preferred in cases where there are few routes. This minimizes traffic created by routing protocols used in the automatic method. The automatic method cuts down on manual entry for large route tables and allows for routes to be changed without service interruption.

Another important element in routing is the default gateway route. This is used while routes are being formed automatically and is a convenient way to direct all IP packets in cases where only one route is needed.

Routing internet protocol (RIP) can be enabled for each port configured for IP encapsulation. The Tx RIP parameter enables the FSU to share the internal routing table with other routers and FRADs attached to the port. The Rx RIP parameter enables the FSU to process routing table information from other routers and FRADs attached to the port.

In addition to RIP, the network port uses inverse ARP (RFC 1490) to associate peer router/FRAD IP addresses to PVC addresses.

The FSU can also respond to requests from peer routers/FRADs seeking an association for their tables. The transmit and receive inverse ARP section can be independently enabled.

Access IP Routing selections by first choosing 1 CONFIGURATION from the Main menu. Then choose IP ROUTING from the Configuration Menu. When using the VT 100 terminal interface, the screen in Figure 8-1 will appear. Full menu trees for these selections are shown in Figures 5-2 (*Front Panel Configuration Menu Tree*) and 5-3 (*VT 100 Configuration Menu Tree*).

```
ADTRAN FSU IP ROUTE MENU LOCAL
1 IP ROUTE TABLE
2 GATEWAY IP ADDRESS=0.0.0.0
3 GATEWAY PORT=NONE
4 GATEWAY DLCI=0
5 TRANSMIT ARP REQUESTS=NO
6 PROCESS RECEIVED ARP PACKETS=NO
7 ARP REFRESH TIME <SECONDS>=0

-----

ENTER SELECTION :
```

Figure 8-1
VT 100 IP Route Menu

IP Route Table

Use these menu options to build a table of addresses for routing data packets based on their IP address. When a packet with the specified IP address is received, it is sent out through the selected port on the specified DLCI. See Figure 8-2.

The IP route table can be used in conjunction with RIP protocol to provide routing paths for the entire IP network. If an IP packet is received with a destination IP not located in the internal routing table (static or RIP), then the gateway route is used.

```

ADTRAN FSU IP ROUTING TABLE                                LOCAL
ENTRY # 0
1 IP ADDRESS=0.0.0.0                                         4 Edit Next Entry
2 DESTINATION PORT=DTE PORT 1                               5 Edit Previous Entry
3 DESTINATION DLCI=0                                         6 Delete This Entry
                                                            7 Add New Entry

-----

ESC TO EXIT  ENTER SELECTION : _

```

Figure 8-2
IP Routing Table Menu

Example Route Table Entry

IP Address=192.239.232.0
Destination Port=Network Port
Destination DLCI=16

This example provides a route for IP address range 192.239.232.1 through 192.239.232.254 using the network port and virtual circuit 16. See the following parameter descriptions.

IP Address (IP ADDR)

Enter the IP address to be routed. This entry identifies an individual host or an entire subnet. To address an entire subnet, enter a value with the host portion equal to 0.

Destination Port (DST PORT)

Select the port on the FSU used to transmit the packets with the specified IP address.

Destination DLCI (DST DLCI)

Enter the virtual circuit to be used when the network port is part of the destination IP path. This selection is only applicable if the corresponding destination port element is set for Network port.

Edit Next Entry (NEXT Key on Front Panel)

Edit the next entry in the address table.

Edit Previous Entry (PREV Key on Front Panel)

Edit the previous entry in the address table.

Delete This Entry (DEL Key on Front Panel)

Delete the current entry in the address table.

Add New Entry (ADD Key on Front Panel)

Add a new entry to the address table.

Gateway IP Address (GW IP ADD)

Enter the Gateway IP address. If an IP packet with an unknown IP address is received, the FSU sends it to the Gateway (which is a router or another FRAD).

Gateway Port (GW PORT)

Enter the port from which the gateway can be reached.

Gateway DLCI (GW DLCI)

If the gateway port is set to Network, this parameter identifies the virtual circuit used to reach the gateway.

Transmit ARP Requests (TX ARP)

This parameter enables the transmit portion of the network port inverse ARP protocol. If enabled, inverse ARP messages will be sent to every DLCI assigned to the network port each ARP refresh time period and inverse ARP responses will be generated.

Process Received ARP Packets (RX ARP)

This parameter enables the receive portion of the network port inverse ARP protocol. If enabled, all inverse ARP messages received are used to associate peer IP addresses with DLCI values.

ARP Refresh Time (ARP REF)

Determine how often an inverse ARP request is sent to every DLCI assigned to the network port.



ARP is used in conjunction with RIP to dynamically resolve IP routes and should be enabled if RIP is enabled.

Chapter 9

System Configuration

SYSTEM CONFIG

Access System Configuration selections by first choosing 1 CONFIGURATION from the Main menu. Then choose SYSTEM CONFIGURATION from the Configuration Menu. Full menu trees for the System Configuration selections are shown in Figures 5-2 (*Front Panel Configuration Menu Tree*) and 5-3 (*VT 100 Configuration Menu Tree*). The VT 100 System Configuration menu is shown in Figure 9-1.

```
ADTRAN FSU SYSTEM CONFIG MENU                                LOCAL

1 CHANGE PASSWORD
2 READ COMMUNITY NAME=
3 WRITE COMMUNITY NAME=
4 TRAP MANAGER DLCI=0
5 TRAP MANAGER IP ADDRESS=0.0.0.0
6 TRAP MANAGER PORT=NONE

-----

-----

ESC TO EXIT  ENTER SELECTION :_
```

Figure 9-1
System Configuration Menu

Change Password

Enter a new password of nine digits or less. The default password is **adtran**.

Read Community Name (RD COM NAME)

Enter the authentication strings used for SNMP management. Match the FSU to the SNMP manager for read privileges.

Write Community Name (WR COM NAME)

Enter the authentication strings used for SNMP management. Match the FSU to the SNMP manager for write privileges.

Trap Manager DLCI (TRAP DLCI)

If the trap manager port is set for Network, this parameter identifies the virtual circuit used for all traps generated by the FSU.

Trap Manager IP Address (TRAP IP ADDR)

Enter the IP address of the SNMP manager to which the FSU sends traps.

Trap Manager Port (TRAP PORT)

Enter the FSU port number used to transmit traps to the SNMP manager.

Chapter 10

Statistics

For descriptions of the VT 100 statistics menus see the following section, *Viewing Statistical Information with the VT 100 Interface*. For front panel menu descriptions, see the section *Viewing Statistical Information with the Front Panel Interface*.

Viewing Statistical Information with the VT 100 Interface

Select View Statistics from the Main menu to access the View Statistics Menu shown in Figure 10-1. From this menu, select to view port (DTE or Network), protocol, or system statistics. Select Reset Statistics to clear all current information.

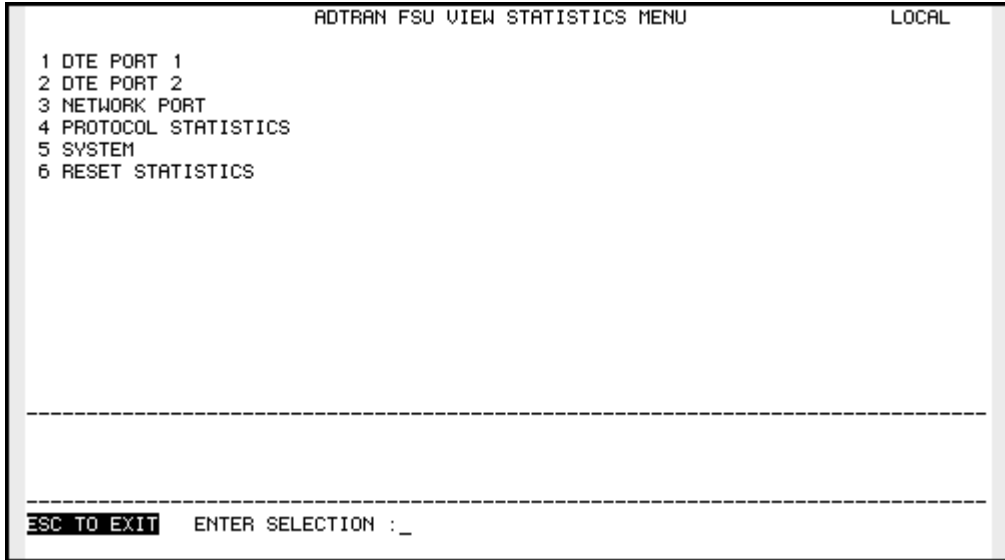

Figure 10-1
View Statistics Menu

DTE and Network Port Statistics

The following sections describe the information given on the DTE port and Network port statistics menus. See Figures 10-2 through 10-5.

Current Statistics

Information given is for the selected port since the last clear.

Leads On

If a lead has become active on the selected port since the last screen refresh, it is listed in the View Statistics menu. See Figure 10-3.

RTS	Request to send
DTR	Data terminal ready
CTS	Clear to send
DSR	Data set ready
DCD	Data carrier detect

Total

Totals given are for the selected port since the last clear.

Rx Frames	Received frames
Tx Frames	Transmitted frames
Rx Bytes	Received bytes
Tx Bytes	Transmitted bytes

Errors

Counts given for the following errors are for the selected port since the last clear:

Rx Errored Frames	Frames dropped due to one or more errors.
CRC Errors	Frames received with CRC16 violations (not available when Trans Async protocol is selected).
Parity Errors	Frames received with parity errors (only available when Trans Async protocol is selected).
Rcv Overrun	Receive FIFO (first in first out) overrun. External clock for network port is too fast.
Inv Formats	Frames received with invalid encapsulation code points.

Buffer Unavailable	Number of packets received without any buffers available indicating a congested situation. Verify flow control is enabled.
Unknown DLCI	All frames received with a DLCI address not already defined by the FSU.
Aborts Rcv	Frames received with abort sequence of seven ones (not available when Trans Async protocol is selected).
Breaks Rcv	Async break characters received (only available when Trans Async protocol is selected).
Frame Errors	Frames received which are violating maximum frame size or are not octet aligned.
DCD Loss	Frames received with DCD falling before the end of the frame.
Port Unavailable	Frames received destined for an inactive port.
Inactive DLCI	Frames received on inactive DLCI.

Signal Statistics

These statistics apply when the DTE port is configured for frame relay protocol or when viewing network statistics.

Tx Signal Frame	Total signaling frames transmitted (polls or responses).
Signal Frame Error	Signal frames received with protocol violations.
Signal State	State of frame relay port (up or down)
Rx Signal Frame	Count of received signal frames (polls or responses).
Signal Timeouts	Count of how many T391 or T392 timeouts have occurred.

CURRENT	ADTRAN FSU VIEW STATISTICS			LOCAL
DTE PORT 1	Leads On -->	CTS	DSR	DCD
TOTAL:				
Rx Frames --->	0	Rx Bytes ---->	0	
Tx Frames --->	0	Tx Bytes ---->	0	
ERRORS:				
Rx Err Frms ->	0	Aborts Rcv -->	0	
CRC Errors -->	0	Frame Errs -->	0	
Rcv Overrun ->	0	DCD Loss ---->	0	
Inv Formats ->	0	Port Unavail >	0	
Buff Unavail >	0	Inactive DLCI >	0	
Unknown DLCI >	0			
Tx Signal Frm>	0	Rx Signal Frm>	0	
Sig Frm Err ->	0	Sig Timeouts >	3	
Sig State --->	DOWN			
ESC-Menu	D-DLCI Stats	P-Protocol Stats	C-Current Stats	F-Freeze

Figure 10-2
DTE Port Statistics Menu-Frame Relay Protocol

CURRENT	ADTRAN FSU VIEW STATISTICS			LOCAL
DTE PORT 1	Leads On -->	CTS	DSR	DCD
TOTAL:				
Rx Frames --->	0	Rx Bytes ---->	0	
Tx Frames --->	0	Tx Bytes ---->	0	
ERRORS:				
Rx Err Frms ->	0	Breaks Rcv -->	0	
Parity Errs ->	0	Frame Errs -->	0	
Rcv Overrun ->	0	DCD Loss ---->	0	
Inv Formats ->	0	Port Unavail >	0	
Buff Unavail >	0	Inactive DLCI >	0	
Unknown DLCI >	0			
ESC-Stats Menu	P-Protocol Stats	C-Current Stats	F-Freeze Stats	
-				

Figure 10-3
DTE Port Statistics Menu-Transparent Async Protocol

CURRENT	ADTRAN FSU VIEW STATISTICS				LOCAL
DTE PORT 1	Leads On -->	CTS	DSR	DCD	
TOTAL:					
Rx Frames --->	0		Rx Bytes ---->	0	
Tx Frames --->	0		Tx Bytes ---->	0	
ERRORS:					
Rx Err Frms ->	0		Aborts Rcv -->	0	
CRC Errors -->	0		Frame Errs -->	0	
Rcv Overrun ->	0		DCD Loss ---->	0	
Inv Formats ->	0		Port Unavail >	0	
Buff Unavail >	0				
Unknown DLCI >	0		Inactive DLCI>	0	
ESC-Stats Menu	P-Protocol Stats		C-Current Stats		F-Freeze Stats

Figure 10-4
DTE Port Statistics Menu-All Other Protocols

CURRENT	ADTRAN FSU VIEW STATISTICS				LOCAL
NETWORK PORT	Leads On -->	RTS	DTR		
TOTAL:					
Rx Frames --->	0		Rx Bytes ---->	0	
Tx Frames --->	139		Tx Bytes ---->	2224	
ERRORS:					
Rx Err Frms ->	0		Aborts Rcv -->	0	
CRC Errors -->	0		Frame Errs -->	0	
Rcv Overrun ->	0		DCD Loss ---->	0	
Inv Formats ->	0		Port Unavail >	0_	
Buff Unavail >	0				
Unknown DLCI >	0		Inactive DLCI>	0	
SIGNAL STATS:					
Tx Signal Frm>	139		Rx Signal Frm>	0	
Sig Frm Err ->	0		Sig Timeouts >	138	
Sig State --->	DOWN				
ESC-Menu	D-DLCI Stats	P-Protocol Stats	C-Current Stats		F-Freeze

Figure 10-5
Network Port View Statistics Menu

CURRENT		ADTRAN FSU VIEW DLCI STATISTICS					LOCAL	
DTE PORT 1								
DLCI		Frames					Bytes	
		In	Out	FECN	BECN	DE	In	Out
16	A	0	0	0	0	0	0	0
995	A	0	0	0	0	0	0	0
UNKNOWN		0	0				0	0
INACTIVE		0	0				0	0

ESC - Stats Menu P - Protocol Stats C - Current Stats F - Freeze Stats

Figure 10-6
View DLCI Statistics Menu-Network Port and Frame Relay Protocol Only

DLCI Statistics

This menu lists every DLCI number for each frame relay port and classifies it as A (active), I (inactive), or U (unknown). See Figure 10-6. A byte and frame break out for the entire unit is also provided including an in/out count as well as a count of how many frames were received with FECN, BECN, or DE (discard eligibility) enabled.



DLCI information for the DTE port is only available when the frame relay protocol is enabled or when viewing network port statistics.

Protocol Statistics

This menu provides information on frames and bytes received/transmitted by the FSU. The information is organized by DTE protocols. Protocols other than those included in the list are

placed in the Other Protocols section and are divided into signaling frames/bytes and frame/byte totals on the network side. See Figure 10-7.

CURRENT	ADTRAN FSU VIEW PROTOCOL STATISTICS				LOCAL
DTE PROTOCOLS:					
	----- Frames -----		----- Bytes -----		
Protocol	In	Out	In	Out	
Frame Relay	0	0	0	0	0
SDLC	0	0	0	0	0
Trans BOP	0	0	0	0	0
Bisync	0	0	0	0	0
Trans Async	0	0	0	0	0
PPP Sync	0	0	0	0	0
PPP Async	0	0	0	0	0
SLIP	0	0	0	0	0
OTHER PROTOCOLS:					
Signal	0	15	0	240	
Network	0	15	0	240	
ESC - Stats Menu C - Current Stats F - Freeze Stats					

Figure 10-7
Protocol Statistics Menu

Hot Keys

Once you have entered one of the statistics menus, hot keys are displayed across the bottom of the screen, allowing you to quickly access other menus. These keys vary depending on the menu currently displayed.

ESC

Press the **ESC** key to return to the main View Statistics menu (shown in Figure 10-1).

DLCI Stats (D)

When viewing Network port statistics or when configured for frame relay on the DTE Port, press **D** to view the DLCI Statistics menu shown in Figure 10-6.

Protocol Stats (P) - DTE and Network Port Menus only

When in any Port Statistics menu, press **P** to view the Protocol Statistics menu shown in Figure 10-7.

Current Stats (C)

Press **C** to resume viewing current status information after a freeze.

Freeze Stats (F)

Press the **F** key to freeze the current statistics.

Viewing Statistical Information with the Front Panel Interface

Select STATS from the Main menu. From this menu, choose to view DTE 1, DTE 2, Network, or System statistics. The first Statistics screen displays. Scroll through the remaining screens using the **Arrow keys**. The number displayed in reverse video in the upper right-hand corner of the screen indicates which port the displayed information applies to (1=DTE 1, 2=DTE 2, N=Network).

Statistics Available for DTE and Network Ports

The following information is displayed when the DTE 1, DTE 2, or NET port is selected.

Control Signal Status Screen

An asterisk (*) indicates that the signal is active for the currently selected port. See Figure 10-8.

RS	request to send
TR	data terminal ready
CS	clear to send
CD	carrier detect
SR	data set ready

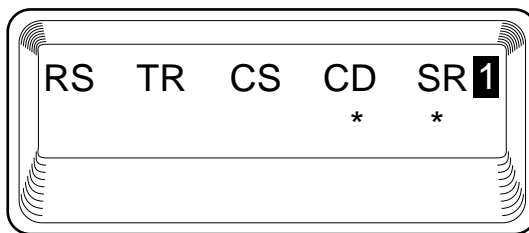

Figure 10-8
Control Signal Status Screen

Frames In

Total received frames since last reset.

Frames Out

Total transmitted frames since last reset.

Errored Frames

Total errored frames received since last reset.

Overrun Errors

Receive FIFO (first in first out) overrun. External clock for network port is too fast.

DCD Loss Errors

Total times the data carrier detect signal was lost since last reset.

CRC Errors

Total occurrences of a cyclic redundancy check error since last reset.

Abort Frames

Total frames aborted since last reset.

Sync Frame Errors

Total synchronous frame errors received since last reset.

Statistics Available Only for the Network Port

The following information is available only when the Network port is selected from the STATS menu.

Signal State

Current state of frame relay port (up or down). See Figure 10-9.

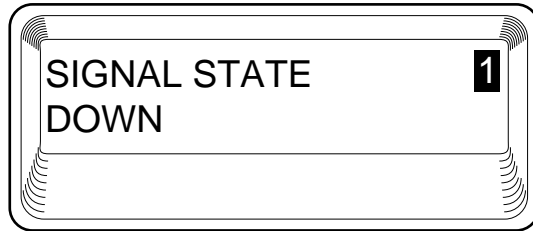

Figure 10-9
Signal State Screen

Signal Timeouts

Total timeouts that have occurred since the last reset.

Signal Errors

Total signal errors received since last reset.

System Statistics

Select **SYS** from the **STATS** menu to display the software version and checksum. This screen is shown in Figure 10-10. Press **Cancel** to return to the **STATS** menu.

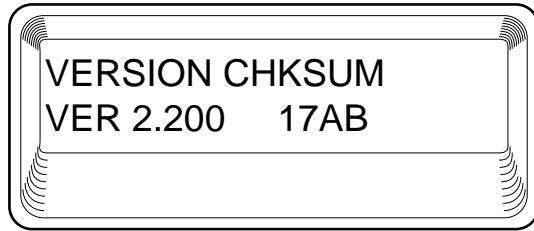

Figure 10-10
System Statistics Screen

Chapter 11

Diagnostics

DIAGNOSTICS

This menu allows you to perform diagnostics by sending ping requests and performing loopback tests. See Figure 11-1 for the VT 100 Diagnostics menu. See Figure 11-2 for the Front Panel menu tree.

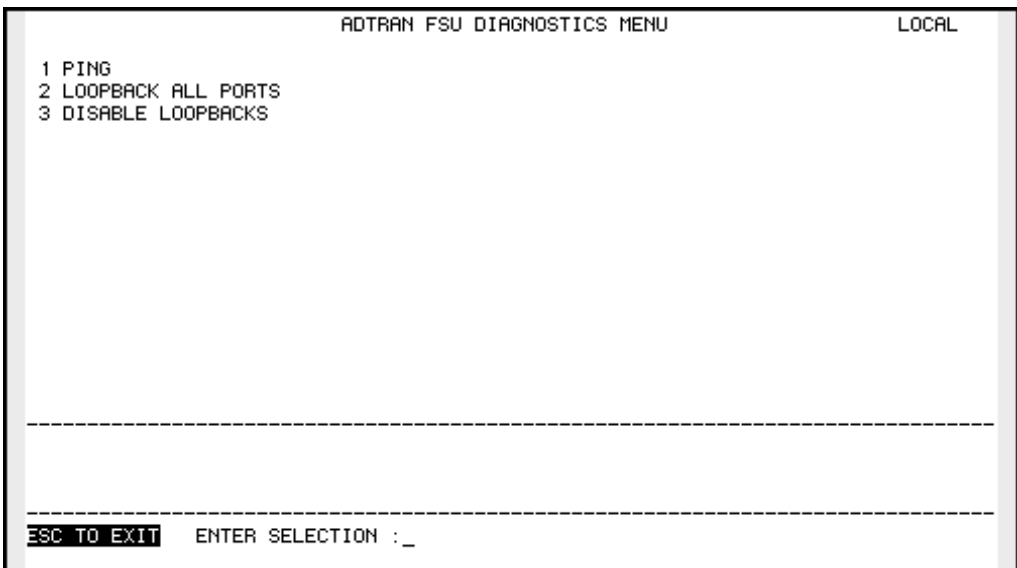

Figure 11-1
VT 100 Diagnostics Menu

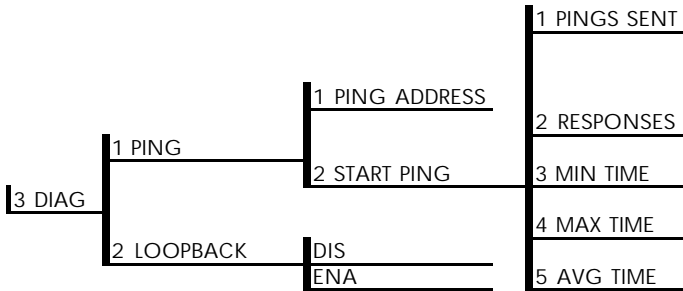

Figure 11-2
Front Panel Diagnostics Menu

Ping

Select **1 PING** to send a ping request to a specific address. See Figure 11-3 for the VT 100 Ping menu.

Address to Ping (PING ADDRESS)

Enter the IP address of the unit the FSU is sending an echo request (ping) to.



*If the IP address is not manually configured into the IP route table, the path will be determined dynamically through RIP and inverse ARP protocols (for more information, see the chapter **Configuring IP Routing**).*

Start Ping

Results are shown once you start the ping. The Start Ping command causes the FSU to send ten ping requests to the target station. At the end of the ten-ping test, the following results are shown:

Pings Sent

This field shows the number of pings sent (always 10).

Responses

This field shows the number of responses received from the pinged device.

Min Time

This field shows the shortest round-trip delay of the received responses. Round-trip delay is counted from the time the ping is sent until the response is received.

Max Time

This field shows the longest round-trip delay of the received responses. If a response is not received before the unit times out, the delay is not calculated in.

Avg Time

This field shows the average response time based on all received responses.

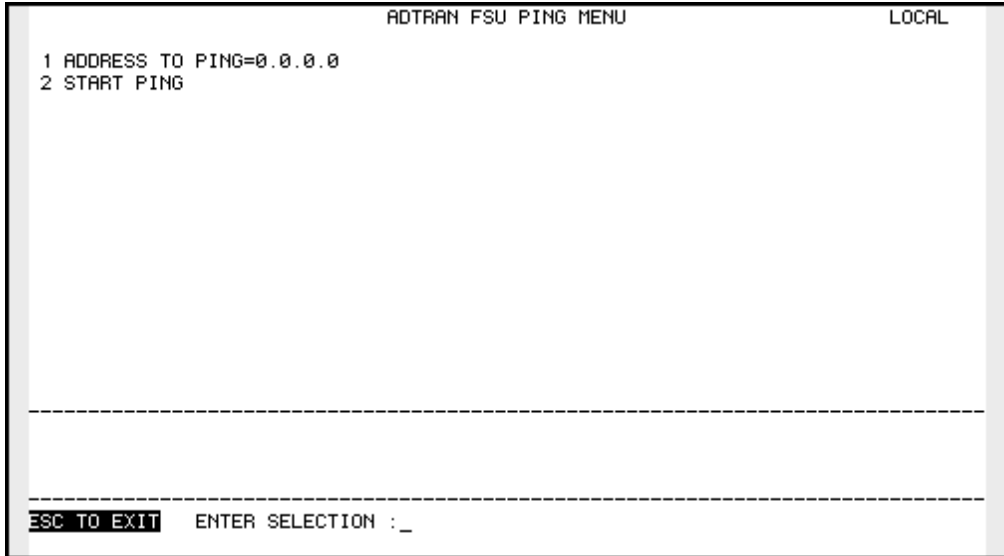

Figure 11-3
VT 100 Ping Menu

Loopback All Ports (LOOPBACK ENA)

This selection places each port (including the network port) into loopback mode. A loopback is an intrusive test used for problem isolation.

Disable Loopbacks (LOOPBACK DIS)

This selection disables active loopbacks tests, returning the unit to normal mode.

Appendix A

Pinouts

The following tables give the pin assignments for the connectors located on the back of the FSU. For more information on the connectors, see the chapter *Installation*.

Table A-A
DTE/DCE Connector Pin Assignments

DB25 Pin#	V.35 Pin#	Function	DTE Port Direction	DCE Port Direction
1	A	FGND		
2		TD(RS232)	I	O
3		RD(RS232)	O	I
4	C	RTS	I	O
5	D	CTS	O	I
6	E	DSR	O	I
7	B	GND		
8	F	DCD	O	I
9		NEG		
10		POS		
11	AA	TC-B(V.35)	O	I
12	Y	TC-A(V.35)	O	I
13	V	RC-A(V.35)	O	I
14	T	RD-B(V.35)	O	I
15		TC(RS232)	O	I
16	R	RD-A(V.35)	O	I
17		RC		
18	S	TD-B(V.35)	I	O
19	P	TD-A(V.35)	I	O
20	H	DTR	I	O
21	W	ETC-B(V.35)	I	O
22				
23	U	ETC-A(V.35)	I	O
24		ETC(RS232)	I	O
25	X	RC-B(V.35)	O	I

I=Input
O=Output

Table A-B
Main Connector Pin Assignments

Pin	Name	Description
1	R1	Transmit Data from DSU to Network-Ring 1
2	T1	Transmit Data from DSU to Network-Tip 1
3-6	-	Not Used
7	T	Receive Data from Network to DSU-Tip
8	R	Receive Data from Network to DSU-Ring

Table A-C
Control Connector Pin Assignments

RJ Pin#	Function	Direction
1	GND	
2	RTS	I
3	TD	I
4	DSR	O
5	RD	O
6	CTS*	O
7	DTR	I
8	DCD	O
*Used for hardware flow control.		

I=Input
O=Output

V.35 ADAPTER CABLE

The V.35 adapter cable allows the FSU to interface with DTE equipment using the V.35 interface. This six foot cable supports data rates of 2.4 kbps to 512 kbps.

ADTRAN part numbers:

male V.35 connector 1200193L1

female V.35 connector 1200194L1

Appendix B

Specifications Summary

SPECIFICATIONS AND FEATURES

This section describes the standard specifications and features incorporated in the FSU.

Operating Modes

Frame relay utilizing DDS or FT1 circuits

Network Interfaces

DDS: 56/64 kbps

Physical: RJ-48S

Control Port Interface

Electrical: RS-232

Physical: RJ-48S (DB-25 with provided adapter)

Async Data Rates: 2.4 to 38.4 kbps

Rates

Data Rates

DDS: 56 and 64 kbps

DCE: up to 512 kbps

DTE Rates Provided

Synchronous rates: 2.4 to 512 kbps

Asynchronous rates: 2.4 to 38.4 kbps

DCE & DTE Interfaces

RS-232
V.35 via adapter cable

SNMP

Internal SNMP agent
MIB II RFC 1213
Frame relay DTE MIB RFC 1315
ADTRAN enterprise MIB
Telnet Access

Clocking

Normal DDS or private network tributary (slaved to network receive clock)
Private network master (internal)

Protocol Support

Each DTE interface may be assigned one of the following

Concentrator

Frame relay

IBM Support

SNA/SDLC with local spoofing
SDLC/HDLC transparent
SDLC-LLC2 translation
Supports up to 20 SDLC PUs on each DTE port

LAN Protocol

SLIP
IP-PPP asynchronous or synchronous

Transparent

Asynchronous transparent
BOP transparent

Protocol encapsulation

IP (SLIP and PPP) and LLC2 protocols are encapsulated using RFC 1490 formats
All other protocols use proprietary formats and require ADTRAN devices at each UNI

Diagnostics

Network

CSU and DSU loopbacks

User

All Port Loopback Mode

Ping Test Mode

Line

Line Requirements

Loop transmission parameters as defined in:

AT&T PUB 62310: Dedicated DDS

Line Interface

RJ-48S, 4-wire, full duplex

Receiver Sensitivity

-45 dB at all rates

FCC Approval

FCC Part 15, Class A and Part 68

Relevant Protocol Standards

Frame Relay

Protocol

ANSI T1.606

ANSI T1.607

ANSI T1.617

ANSI T1.618

ITU Q.922

ITU Q.933

Frame Relay Forum FRF 1.1

Encapsulation

RFC 1490

Frame Relay Forum FRF 3.1

SDLC

IBM #GA27-3093-4

2780/3780 BISYNC

IBM #GA27-3004-2

LLC
ANSI/IEEE 802.2

PPP
RFC 1661
RFC 1662

SLIP
RFC 1055

SNMP MIB
RFC 1315
RFC 1213

Environment

Operating temperature: 0 to 50°C (32 to 122°F)
Storage: -20 to 70°C (-4 to 158°F)
Relative humidity: Up to 95%, non-condensing
Dimensions: 2.5"H, 7.75"W, 10.375"L
Weight: 3 lbs

Power

115 VAC, 60 Hz, 8 W

Acronyms and Abbreviations

ACK	acknowledgment
ANSI	American National Standards Institute
AR	access rate
ARP	address resolution protocol
async	asynchronous
BECN	backward explicit congestion notification
BOP	bit oriented protocol
CCITT	Consultive Committee for International Tele- phony and Telegraphy
CD	carrier detect
CO	central office
CPE	customer premise equipment
CRC	cyclic redundancy check
CS	clear to send
CSU	channel service unit
CTS	clear to send
dB	decibel
DBU	dial backup
DCD	data carrier detect
DCE	data communications equipment
DDS	digital data service
DE	discard eligible
DLCI	data link connection identifier
DSAP	directory scope analysis program
DSR	data set ready
DSU	data service unit
DTE	data terminal equipment
DTR	data terminal ready

FECN	forward explicit congestion notification
FEP	front end processor
FIFO	first in first out
FR	frame relay
FRAD	frame relay access device
FRF	frame relay forum
FSU	frame relay service unit
HDLC	high-speed data link control
IP	internet protocol
ISDN	integrated services digital network
ITU	International Telecommunications Union
KA	keep alive
LAN	local area network
LED	light emitting diode
LLC	logical link control
LMI.....	local management interface
LRC	lateral redundancy check
MIB.....	management information base
ms	millisecond
NRZ	non-return to zero
NRZI	non-return to zero inverted
OCU	office channel unit
OOS.....	out of service
PPP	point to point protocol
PU	physical unit
PVC	permanent virtual circuit
RD	receive data
RDL	remote digital loopback
RFC	request for comments
RFECN	remote forward explicit congestion notification
RIP	routing information protocol
RMA.....	return material authorization
RR	receiver ready
RS	recommended standard
RTS	request to send
Rx	receive
SAP	service access point
SDLC	synchronous data link control
SLIP	serial line internet protocol
SNA.....	systems network architecture

SNMP	simple network management protocol
SNRM	set normal response mode
SR	data set ready
SVC	switched virtual circuit
SW56	switched 56
sync	synchronous
TD	transmit data
TR	data terminal ready
Tx	transmit
UNI	user-to-network interface
VRC	vertical redundancy check
WAN	wide area network
XID	exchange identification
XMIT	transmit

Glossary

2-wire Switched 56

A Northern Telecom proprietary 56 kbps switched digital data service offered by telco service providers, and delivered to users over a single pair of copper wires. Compatible with the ADTRAN DSU III S2W and with the FSU 2-wire Switched 56 TDM option.

4-wire Switched 56

An AT&T proprietary 56/64 kbps switched digital data service offered by telco service providers and delivered to users over 4 copper wires. Compatible with the ADTRAN DSU III S4W and with the FSU 4-wire Switched 56 TDM option.

American National Standards Institute (ANSI)

Devices and proposes recommendations for international communications standards.

asynchronous

A method of data transmission which allows characters to be sent at irregular intervals by preceding each character with a start bit, followed by a stop bit.

backward explicit congestion notification (BECN)

A bit set by a frame relay network to notify an interface device (DTE) that congestion avoidance procedures should be initiated by the sending device.

bandwidth

The bandwidth determines the rate at which information can be sent through a channel (the greater the bandwidth, the more information that can be sent in a given amount of time).

bridge

A device that supports LAN-to-LAN communications. Bridges may be equipped to provide frame relay support to the LAN devices they serve. A frame relay capable bridge encapsulates LAN frames in frame relay frames and feeds them to a frame relay switch for transmission across the network. A frame relay capable bridge also receives frame relay frames from the network, strips the frame relay frame off each LAN frame, and passes the LAN frame on to the end device. Bridges are generally used to connect LAN segments to other LAN segments or to a WAN. They route traffic on the Level 2 LAN protocol (e.g. the Media Access Control address), which occupies the lower sub-layer of the LAN OSI data link layer. See also *router*.

CCITT

Consultive Committee for International Telephony and Telegraphy. A standards organization that devises and proposes recommendations for international communications. See also *American National Standards Institute (ANSI)*.

CD

carrier detect. A signal generated by a modem or DSU/CSU. CD indicates the presence of a carrier signal on a communications link.

channel service unit

CSU. A device used to connect a digital phone line (T1 or Switched 56 line) coming in from the phone company to either a multiplexer, channel bank, or directly to another device producing a digital signal; for example, a digital PBX, a PC, or data communications device. A CSU performs certain line-conditioning and equalization functions, and responds to loopback commands sent from the central office. A CSU regenerates digital signals. It monitors them for problems, and provides a way of testing the digital circuit.

clocking

An oscillator-generated signal that provides a timing reference for a transmission link. A clock provides signals used in a transmission system to control the timing of certain functions. The clock has two functions, (1) to generate periodic signals for synchronization and (2) to provide a time base.

CPE

Customer premise equipment. All telecommunications terminal equipment located on the customer premises, including telephone sets, private branch exchanges (PBXs), data terminals, and customer-owned coin-operated telephones.

CRC

Cyclic redundancy check. A computational means to ensure the accuracy of frames transmitted between devices in a frame relay network. The mathematical function is computed, before the frame is transmitted, at the originating device. Its numerical value is computed based on the content of the frame. This value is compared with a recomputed value of the function at the destination device. See also frame check sequence (FCS).

CS

See CTS.

CSU

See *Channel Service Unit*.

CTS

Clear to send. A signal on the DTE interface indicating that the DCE is clear to send data.

data service unit

DSU. A device designed to transmit and receive digital data on digital transmission facilities.

dB

Decibel. A unit of measure of signal strength, usually the relation between a transmitted signal and a standard signal source.

data communications equipment (DCE)

Device that provides all the functions required for connection to telephone company lines and for converting signals between telephone lines and DTE. Also see *DTE*.

DDS

digital data service. A private line digital service, for transmitting data end-to-end at speeds of 2.4, 4.8, 9.6, and 56 kbps and in some cases 19.2, 38.4, or 64 kbps. The systems can use central hub offices for obtaining test access, bridging legs of multipoint circuits, and cross connecting equipment. DDS is offered on an inter-LATA basis by AT&T and on an intra-LATA basis by the Bell operating companies.

data link connection identifier (DLCI)

A unique number assigned to a PVC end point in a frame relay network. Identifies a particular PVC endpoint within a user's access channel in a frame relay network and has local significance only to that channel.

discard eligibility (DE)

A user-set bit indicating that a frame may be discarded in preference to other frames if congestion occurs, to maintain the committed quality of service within the network. Frames with the DE bit set are considered Be excess data. See also *excess burst size (Be)*.

DSU

See *Data Service Unit*.

DSU loopback

A telco initiated test which loops the DSU back to the telco and is used to test the DDS circuit as well as the DSU/CSU.

DTE

data terminal equipment. The end-user terminal or computer that plugs into the termination point (DCE) of a communications circuit. The main difference between the DCE and the DTE is that pins two and three are reversed.

end device

The ultimate source or destination of data flowing through a frame relay network sometimes referred to as DTE. As a source device, it sends data to an interface device for encapsulation in a frame relay frame. As a destination device, it receives de-encapsulated data (i.e., the frame relay frame is stripped off, leaving only the user's data) from the interface device. Also see *DCE*.

encapsulation

A process by which an interface device places an end device's protocol-specific frames inside a frame relay frame. The network accepts only frames formatted specifically for frame relay; therefore interface devices acting as interfaces to a frame relay network must perform encapsulation. See also *interface device* or *frame relay capable interface device*.

E1

Transmission rate of 2.048 Mbps on E1 communications lines. An E1 facility carries a 2.048 Mbps digital signal. See also T1 and channel.

file server

In the context of frame relay network supporting LAN-to-LAN communications, a device connecting a series of workstations within a given LAN. The device performs error recover and flow control functions as well as end-to-end acknowledgment of data during data transfer, thereby significantly reducing overhead within the frame relay network.

forward explicit congestion notification (FECN)

A bit set by a frame relay network to notify an interface device (DTE) that congestion avoidance procedures should be initiated by the receiving device. See also *BECN*.

frame check sequence (FCS)

The standard 16-bit cyclic redundancy check used for HDLC and frame relay frames. The FCS detects bit errors occurring in the bits of the frame between the opening flag and the FCS, and is only effective in detecting errors in frames no larger than 4096 octets. See also *cyclic redundancy check (CRC)*.

frame-relay-capable interface device

A communications device that performs encapsulation. Frame-relay-capable routers and bridges are examples of interface devices used to interface the customer's equipment to frame relay network. See also *interface device* and *encapsulation*.

frame relay frame

A variable-length unit of data, in frame-relay format that is transmitted through a frame relay network as pure data. Contrast with *packet*. See also *Q.922A*.

frame relay network

A telecommunications network based on frame relay technology. Data is multiplexed. Contrast with packet switching network.

high level data link control (HDLC)

A generic link-level communications protocol developed by the International Organization for Standardization (ISO). HDLC manages synchronous code-transparent, serial information transfer over a link connection. See also synchronous data link control (SDLC).

hop

a single trunk line between two switches in a frame relay network. An established PVC consists of a certain number of hops, spanning the distance from the ingress access interface to the egress access interface within the network.

host computer

The primary or controlling computer in a multiple computer operation.

in-band

Signaling (dialing, diagnostics, management, configuration, etc.) over the same channel used for data.

ingress

Frame relay frames leaving from an access device in a direction toward the frame relay network. Contrast with *egress*.

interface device

Provides the interface between the end device(s) and a frame relay network by encapsulating the user's native protocol in frame relay frames and sending the frames across the frame relay backbone. See also *encapsulation* and *frame-relay-capable interface device*.

ISDN

Integrated Services Digital Network. A network architecture that enables end-to-end digital connections. The network supports diverse services through integrated access arrangements and defines a limited set of standard, multipurpose interfaces for equipment vendors, network providers, and customers. Interworking with a public switched telephone network is retained.

local area network (LAN)

A privately owned network that offers high-speed communications channels to connect information processing equipment in a limited geographic area.

out-of-band

Signaling that is separated from the channel carrying information (voice, data, video, etc.). Typically the separation is accomplished by a filter. The signaling includes dialing and other supervisory signals.

packet

A message containing both control information and data. The control information is used for routing the packet through a network to its final destination. Contrast with *frame relay frame*.

packet-switching network

A telecommunications network based on packet-switching technology, wherein a transmission channel is occupied only for the duration of the transmission of the packet. Contrast with frame relay network.

parameter

A numerical code that controls an aspect of terminal and/or network operation. Parameters control such aspects as page size, data transmission speed, and timing options.

permanent virtual circuit (PVC)

A frame relay logical link, whose endpoints and class of service are defined by network management. Analogous to an X.25 permanent virtual circuit, a PVC consists of the originating frame relay network element address, originating data link control identifier, terminating frame relay network element address, and termination data link control identifier. Originating refers to the access interface form which the PVC is initiated. Terminating refers to the access interface at which the PVC stops. Many data network customers require a PVC between two points. Data terminating equipment with a need form continuous communion use PVCs. See also data link connection identifier (DLCI).

ping

An internet protocol standard that provides loopback on demand for any device in an IP network. One device "pings" another by sending a loopback request to the device's IP address.

point-to-point

Type of communications link that connects a single device to another single device, such as a remote terminal to a host computer.

RDL

Remote digital loopback.

remote configuration

A feature designed into ADTRAN DSU/CSU products that allow remote DSU/CSU to be configured from a local DSU/CSU or VT100 compatible terminal.

router

A device that supports LAN-to-LAN communications. Routers may be equipped to provide frame relay support to the LAN devices they serve. A frame-relay-capable router encapsulates LAN frames in a frame relay frames and feeds those frame relay frames to a frame relay switch for transmission across the network. A frame-relay-capable router also receives frame relay frames from the network, strips the frame relay frame off each frame to produce the original LAN frame, and passes the LAN frame on to the end device. Routers connect multiple LAN segments to each other or to a WAN. Routers route traffic on the Level 3 LAN protocol (e.g., the internet protocol address). See also *bridge*.

service

The provision of telecommunications to customers by a common carrier, administration, or private operating agency, using voice, data, and/or video technologies.

SNMP

Simple Network Management Protocol. A control and reporting scheme widely used to manage devices from different vendors. SNMP operates on top of the Internet protocol.

SR

Data set ready. A signal on the EIA-232 interface that indicates if the communications is connected and ready to start handshaking control signals so communications can begin.

statistical multiplexing

Interleaving the data input of two or more devices on a single channel or access line for transmission through a frame relay network. Interleaving of data is accomplished using the DLCI.

switched network

The network of dial-up telephone lines using circuit switching to provide communications services to network users.

synchronous

Communications in which the timing is achieved by sharing a single clock. Each end of the transmission synchronizes itself with the use of clocks and information sent along with the transmitted data.

synchronous data link control (SDLC)

A link-level communications protocol used in an international business machines (IBM) systems Network Architecture (SNA) network that manages synchronous, code-transparent, serial information transfer over a link connection. SDLC is a subset of the HDLC protocol developed by ISO.

T1

Transmission rate of 1.544 Mbps on T1 communication lines. A T1 facility carries a 1.544 Mbps digital signal. Also referred to as digital signal level 1 (DS-1). See also *E1* and *channel*.

trunk line

A communications line connecting two frame relay switches to each other.

VT 100

A non-intelligent terminal or terminal emulation mode used for asynchronous communications. Used to configure the FSU.

Index

Symbols

56/64 DDS DSU 2, 3, 5, 69

A

abort 20

abort changes 20

abort frames 97

aborts rcv 90

Ack TO

network port 74

activating menu items 16

adapter cable 8

ADD key 11, 12

add new entry

bisync protocol 56

frame relay protocol 46

IP routing 80

SDLC protocol 50

address

DLCI 50

address table 24, 45

frame relay 42

PPP async protocol 64

PPP synchronous protocol 61

slip protocol 67

address to ping

diagnostics 102

addressing 1

alarm conditions 15

alarm/test 15

all ones

Frame Relay Protocol 42

SDLC protocol 47

transparent BOP protocol 52

ALM/TST 15

ANSI 1

ANSI T1.617-D 69

frame relay protocol 44

application 21

bisync 27

SNA and LAN 25

SNA and LAN with SNMP/telnet management 24

SNA/SDLC with local spoofing 21

SNMP/telnet management 25

transparent 30

ARP 24, 77, 81

ARP REF

IP routing 81

ARP refresh time

IP routing 81

arrows 12

asynchronous bit rate

PPP async protocol 62, 65

transparent async protocol 58

asynchronous protocol 2

speeds 2

avg time

diagnostics 103

B

BACKUP 8

connector 6, 7, 8

- BECN 42, 93
- begin remote session 17
- bisync 2, 27, 28
 - application 27
- bisync protocol 53
 - menu tree 53
- bit rate
 - network port 72
 - PPP async protocol 62, 65
 - transparent async protocol 58
- bit-oriented protocol 2
- BOP 51
- break characters 58
- breaks rcv 90
- buffer unavailable 90
- busy TO
 - network port 74
- byte
 - length
 - PPP async protocol 62, 65
 - transparent async protocol 58

C

- C/R 42
- cable
 - EIA-232 5
 - V.35 5
- cable lengths 8
- cancel key 12
- change password
 - system configuration 84
- clock source
 - network port 72
- clocking 110
- Config 16, 19
- configuration 16, 19, 21
 - bisync 29
 - default 34
 - DTE ports 8, 39
 - for SNA/SDLC application 23
 - local 33
 - network port 69
 - remote 33
 - SNA and LAN application 26

- system 83–85
- configuration changes
 - when implemented 20
- configuration menus 34
 - front panel 37
 - VT 100 35
- congestion control 1
- conn
 - bisync protocol 54
 - frame relay protocol 42
 - PPP async protocol 62, 65
 - PPP synchronous protocol 60
 - SDLC protocol 47
 - transparent async protocol 58
 - transparent BOP protocol 52
- connection
 - network port 69
 - to user equipment 2
- connectors 7
- CONTROL
 - port 6, 7, 9, 17, 107
- control lead status 58
- CONTROL port 109
- controller address
 - SDLC protocol 49
- CRC errors 89, 97
- CRC16 1
- CRC16 violations 89
- CTRL ADDR
 - SDLC protocol 49
- CTS 89
- current statistics 89, 95
- customer service 4

D

- data bits
 - PPP async protocol 62, 65
 - transparent async protocol 58
- data format
 - bisync protocol 54
- data link connection identifier 1
- data rates 109
- DB25
 - connector 6

- DCD 89
- DCD loss 90
- DCD loss errors 97
- DCE 6
 - connector 8
 - port emulation 2
- DCE connection 8
- DCE port 3, 7
- DDS 2
 - alarm conditions 15
- DDS network
 - connecting to 8
- DE 42, 93
- dedicated circuit
 - connecting to 7
 - connection to 6
- default
 - configuration 34
- DEL key 11, 12
- DELAY
 - SDLC protocol 49
- delete this entry 46, 50, 56, 80
- destination address 2
- destination DLCI
 - IP routing 80
- destination port
 - IP routing 80
- DIAG 19
- diagnostics 19, 101, 111
- diagnostics menu
 - front panel 102
 - VT 100 101
- dial backup
 - connection to 6
- disable loopbacks
 - diagnostics 104
- discard eligibility 93
- DLCI 1, 17, 24, 45, 46
 - address 42, 50, 56
 - frame relay protocol 45
 - IP routing 79
 - management 24
 - network 45
- DLCI statistics 93
- DLCI Stats 94
- down arrow 12
- DSAP 50, 55
- DSR 89
- DST DLCI
 - IP routing 80
- DST PORT
 - IP routing 80
- DSU
 - external 2, 70
 - internal 2
- DSU option 5
- DSU/CSU
 - alarm conditions 15
- DTE
 - statistics 87
- DTE 1 port 6, 7
- DTE 2 port 6, 7
- DTE and network port statistics 88
- DTE connection 8
- DTE device
 - connecting to 7
- DTE interface
 - operating speed
 - bisync protocol 54
 - PPP async protocol 62, 65
 - PPP synchronous protocol 61
 - SDLC protocol 47
 - transparent BOP protocol 52
- DTE port 2
 - configuration 39–67
 - configuring 8
- DTE port 1 16, 19
- DTE port 2 19
 - configuration 33
- DTE port DLCI
 - frame relay protocol 45
- DTE port view statistics menu
 - all other protocols 92
 - frame relay protocol 91
 - transparent asyc protocol 91
- DTE rates 109
- DTR 89

E

- edit next entry 45, 50, 56, 80
- edit previous entry 46, 50, 56, 80
- EIA-232 8
 - cable 5
- EMUL TYPE
 - bisync protocol 54
- emulation 21, 24
- emulation type
 - bisync protocol 54
 - SDLC protocol 48
- encapsulation 2
- enter key 11
- equipment
 - provided 5
 - sold separately 5
- error threshold
 - defining 44
- errored frames 97
- errors 89
- ESC
 - hot keys 94
- exchange identification 22

F

- far end port number
 - transparent async protocol 58
 - transparent BOP protocol 52, 58
- FCC approval 111
- FE PORT
 - transparent BOP protocol 52, 58
- FECN 42, 93
- FEP 46
- FIFO 89, 97
- flags 1
 - frame relay protocol 42
 - PPP synchronous protocol 61
 - SDLC protocol 47
 - transparent BOP protocol 52
- FLASH code 3
- FORMAT
 - bisync protocol 54
 - SDLC protocol 48

FR OPT

- network port 72
- FRAD 21, 42
- frame errors 90
- frame processing 2
- frame relay 21, 42, 58, 109, 110
 - address table 24
 - alarm conditions 15
 - general description 1
 - private network 2
 - public network 2
- frame relay options
 - network port 72
- frame relay protocol 42, 69
 - menu tree 43
- frames in 97
- frames out 97
- freeze stats 95
- front panel 3, 11
 - configuration menu tree 34, 37
 - operation 16
- front-end processors 46

G

- gateway 24, 77
- gateway DLCI
 - IP routing 81
- gateway IP address
 - IP routing 81
- gateway port
 - IP routing 81
- GROUP ADDR
 - SDLC protocol 49
- group address 49
 - SDLC protocol 49
- GW DLCI
 - IP routing 81
- GW IP ADD
 - IP routing 81
- GW PORT
 - IP routing 81

H

hardware flow control 54
HDLC 51
header 1
hot keys 94

I

IBM support 110
idle

- bisync protocol 54
- frame relay protocol 42
- PPP synchronous protocol 61
- SDLC protocol 47
- transparent BOP protocol 52

inactive DLCI 90
installation 5–9
INT TYPE

- network port 71

inter-LATA 3
interface type

- bisync protocol 54
- frame relay protocol 42
- network port 71
- PPP async protocol 62, 65
- PPP synchronous protocol 60
- SDLC protocol 47
- transparent async protocol 58
- transparent BOP protocol 52

interfaces

- DCE 110
- DTE 110

internal routing table 77
internet protocol 2
inv formats 89
inverse ARP 24, 77
IP 2, 69
IP address 24, 44

- frame relay protocol 45
- IP routing 80
- PPP async protocol 64, 67
- PPP synchronous protocol 61, 64, 67

IP encapsulation 77
IP packet 79

IP route menu

- VT 100 78

IP route table 79
IP routing 59, 62, 65, 77
IP routing table menu

- VT 100 79

IP traffic 59, 65
ITU Q.933-A 69
ITU-T Q.933-A

- frame relay protocol 44

K

KA TO

- network port 74

keypad 11

L

LAN 24, 25, 26
LAN protocol 110
LCD window 11
leads on 89
LED

- ALM/TST description 15
- RD1
- RD2
- RDN
- TD1
- TD2
- TDN

LINE

- bisync protocol 54

line interface 111
line requirements 111
line type

- bisync protocol 54

LLC 22, 27
LLC DSAP

- SDLC protocol 50, 55

LLC SSAP

- SDLC protocol 50, 55

LLC2 46, 69
LLC2 ACK timeout

- network port 74
- LLC2 busy timeout
 - network port 74
- LLC2 DSAP 46
 - SDLC protocol 50, 55
- LLC2 k window size
 - network port 74
- LLC2 keep-alive timeout
 - network port 74
- LLC2 link 21
- LLC2 N2 retry counter
 - network port 74
- LLC2 OPT
 - network port 74
- LLC2 options
 - network port 74
- LLC2 poll timeout
 - network port 74
- LLC2 reject timeout
 - network port 74
- LLC2 SSAP 46
 - SDLC protocol 50, 55
- LMI 69
- local configuration 33
- local IP address
 - network port 75
- local login 17
- local spoofing 21
- login menu 17, 18
- logout 20
- loop rate
 - network port 71
- loopback all ports
 - diagnostics 104
- LOOPBACK DIS
 - diagnostics 104
- LOOPBACK ENA
 - diagnostics 104

M

- MAIN
 - connector 6, 8, 107
- main menu 18
- main menu branches

- abort 19
- diagnostics 19
- logout 19
- save 19
- statistics 19
- main telco connector 7
- management DLCI 24
 - Frame Relay Protocol 45
- max time
 - diagnostics 103
- menu items
 - selecting 11
- menu travel 16
- min time
 - diagnostics 103
- mixed environment
 - application 24
- MNG DLCI
 - frame relay protocol 45
- multi-point 27, 28, 54, 55

N

- N2 RETRY
 - network port 74
- N391
 - network port 73
- N392
 - frame relay protocol 44, 73
- N393 44
- NET DLCI
 - frame relay protocol 45
- network
 - interface connection 6
 - statistics 87
- network devices 22
- network DLCI
 - frame relay protocol 45
- network interfaces 109
- network port
 - configuration 69
 - configure first 69
- network port configuration
 - menu tree 70
 - VT 100 menu 71

- network port frame relay options menu
 - VT 100 72
- network port LLC2 options menu
 - VT 100 75
- network port view statistics menu 92
- NEXT key 11, 12
- NRZ
 - bisync protocol 54
 - SDLC protocol 48
- NRZI
 - bisync protocol 54
 - SDLC protocol 48
- numeric keypad 11

O

- ones
 - PPP synchronous protocol 61
- opening menu 19
- operating modes 109
- operation 11–20
- options 3
- OUT DLCI
 - SDLC protocol 50, 56
 - transparent BOP protocol 52, 59
- outgoing DLCI
 - SDLC protocol 50, 56
 - transparent BOP protocol 52
- overrun errors 97

P

- parity
 - PPP async protocol 62, 65
 - transparent async protocol 58
- parity errors 89
- password 17
 - default 17
- peer IP address
 - PPP synchronous protocol 61, 64, 67
- peer PPP device 64
- peer PPP station 61, 64
- peer SLIP station 67
- permanent virtual circuits 1
- physical layer options 19, 40

- bisync protocol 54
- network port 71
- port disabled protocol 41
- PPP async protocol 62
- PPP synchronous protocol 60
- SDLC protocol 47
- slip protocol 65
- transparent async protocol 58
- transparent BOP protocol 52
- pin assignments 6
 - CONTROL connector 107
 - DTE/DCE connectors 106
 - MAIN connector 107
- ping
 - diagnostics 102
- ping address
 - diagnostics 102
- ping menu
 - VT 100 104
- pings sent
 - diagnostics 103
- pinouts 105
- point-to-point 27, 54, 55
 - connection on the network 50
 - protocol 2
- POLL RAT
 - bisync protocol 55
 - SDLC protocol 49
- POLL TO
 - network port 74
- poll/response timeout
 - bisync protocol 55
- poll/response timer threshold
 - bisync protocol 55
- polling 49, 55, 69
- port
 - RS-232 2
 - V.35 2
- port disabled
 - menu tree 41
 - protocol 41
- port unavailable 90
- ports 7
- power cord 7

- power up 6
 - PPP 2
 - PPP asynchronous protocol 62
 - menu tree 63
 - PPP synchronous 59
 - PPP synchronous protocol 59
 - menu tree 60
 - PREV key 11, 12
 - priority queu ratio
 - network port 76
 - private network 2
 - process received ARP packets
 - IP routing 81
 - process received RIP packets
 - network port 76
 - product overview 1–2, 2
 - protocol 16, 19
 - configuration 33, 40
 - statistics 87
 - protocol address table 19, 40, 45
 - bisync protocol 55
 - frame relay protocol 45
 - port disabled protocol 41
 - SDLC protocol 49
 - transparent async protocol 58
 - transparent BOP protocol 52
 - protocol options 19, 40
 - bisync protocol 54
 - frame relay protocol 44
 - port disabled protocol 41
 - PPP async protocol 63
 - PPP synchronous protocol 61
 - SDLC protocol 48
 - slip protocol 66
 - transparent BOP protocol 52
 - protocol standards 111
 - protocol statistics 93
 - protocol support 110
 - PRT DLCI
 - frame relay protocol 45
 - PU 49, 55
 - PU 2.1 device 21
 - PU address 46
 - requirements 46
 - public network 2
 - PUL 24
 - PVC 1, 24, 69, 77
- ## R
- RATE
 - bisync protocol 54
 - frame relay protocol 42
 - PPP synchronous protocol 61
 - SDLC protocol 47
 - transparent BOP protocol 52
 - rcv overrun 89
 - RD COM NAME
 - unit configuration 84
 - RD1 15
 - RD2 15
 - RDN 15
 - read community name
 - system configuration 84
 - rear panel 6, 7
 - receipt inspection 5
 - receive data
 - DTE 1 15
 - DTE 2 15
 - network 15
 - receiver sensitivity 111
 - reject to
 - network port 74
 - remote configuration 33, 56
 - remote FECN notification
 - network port 73
 - remote login 17
 - remote management 3
 - reply to RIP requests
 - PPP synchronous protocol 61, 64, 67
 - responses
 - diagnostics 103
 - return material authorization (RMA) 4
 - RFC 1315 2, 3
 - RFC 1490 22, 77
 - RFECN
 - network port 73
 - RIP
 - 24, 59, 61, 62, 64, 65, 67, 75, 77, 79, 81
 - RIP REPLY 61, 64, 67

- router 24, 44
- routing 59, 62, 65
- routing information protocol 61, 64, 67, 75
- routing paths 79
- routing table 77
 - automatic entry 77
 - entry example 80
 - manual entry 77
- routing tables 59, 62, 64, 65
- RS-232 2, 110
 - bisync protocol 54
 - frame relay protocol 42
 - PPP Async Protocol 65
 - PPP async protocol 62
 - PPP dynchronous protocol 60
 - SDLC protocol 47
 - transparent async protocol 58
 - transparent BOP protocol 52
- RTS 89
- RX ARP
 - IP routing 81
- Rx errored frames 89
- Rx frames
 - statistics 89
- Rx signal frame 90
- S**
- SAP 46
- save 20
- save configuration 20
- SDLC 2, 21, 22, 24, 46, 50, 55
- SDLC links 21
- SDLC poll/response timeout
 - SDLC protocol 49
- SDLC protocol 46, 49
 - menu tree 48
- SDLC slow poll ratio
 - SDLC protocol 49
- SDLC-LLC2 translation 110
- SDLC/HDLC transparent 110
- service access points 46
- set normal response mode 21
- SHIFT key 11, 16
- SIGNAL
 - frame relay protocol 44
 - network port 73
 - signal errors 98
 - signal frame error 90
 - signal state 90, 98
 - signal statistics 90
 - signal timeouts 90, 98
 - signaling format 69
 - signaling type
 - frame relay protocol 44
 - network port 73
 - simple network management protocol 2
 - slip 2, 65, 110
 - slip protocol 65
 - menu tree 66
 - slow poll list 49, 55
 - slow poll ratio <N:1>
 - bisync protocol 55
 - SNA 25, 26
 - SNA and LAN application 24
 - SNA networks 46
 - SNA with local spoofing 22
 - SNA/SDLC 110
 - SNA/SDLC with local spoofing 21
 - SNMP 2, 3, 24, 25, 44, 45, 110
 - SNMP/telnet management
 - application 24
 - SNRM 21
 - software upgrade 3
 - specifications 109
 - spoofing 21, 27
 - local 21
 - SSAP 50, 55
 - SSAP/DSAP 46
 - start ping
 - diagnostics 103
 - static route entries 59, 62, 65
 - static routing
 - additional configuration required 59, 62, 65
 - statistics
 - DTE and network ports 96
 - network port only 98

- viewing 87
 - front panel 96
 - VT 100 87
 - STATS 19
 - status information 24
 - status menu 44
 - stop bits
 - PPP async protocol 62, 65
 - transparent async protocol 58
 - subnet mask 44, 45, 61, 64, 67, 75
 - SVC 1
 - switched virtual circuit 1
 - sync frame errors 97
 - synchronous bit rate
 - bisync protocol 54
 - PPP synchronous protocol 61
 - SDLC protocol 47
 - transparent BOP protocol 52
 - synchronous data link control 2
 - synchronous idle method
 - bisync protocol 54
 - frame relay protocol 42
 - PPP synchronous protocol 61
 - SDLC protocol 47
 - transparent BOP protocol 52
 - synchronous protocol
 - speeds 2
 - system
 - statistics 87
 - system configuration 83
 - system statistics 99
- ## T
- T1/FT1 2
 - T391
 - network port 73
 - T392
 - frame relay protocol 44
 - TD1 15
 - TD2 15
 - TDN 15
 - telco connectors 8
 - telnet 3, 24, 25, 44, 45
 - capability 3
 - terminal
 - configuration 33
 - connection/operation 17
 - terminal interface 34. *See also* VT 100
 - connecting to 7
 - connection to 9
 - threshold
 - bisync protocol 55
 - SDLC protocol 49
 - timeout 49, 55
 - bisync protocol 55
 - SDLC protocol 49
 - trans async 57
 - trans BOP 51
 - translation code 54
 - transmit ARP requests
 - IP routing 81
 - transmit data
 - DTE 1 15
 - DTE 2 15
 - network 15
 - transmit delay
 - SDLC protocol 49
 - transmit RIP requests 61, 64, 67
 - network port 75
 - transparent application 30
 - transparent async protocol 57
 - menu tree 57
 - transparent BOP protocol 51
 - menu tree 51
 - trap DLCI
 - system configuration 85
 - trap IP address
 - system configuration 85
 - trap manager DLCI
 - system configuration 85
 - trap manager IP address
 - system configuration 85
 - trap manager port
 - system configuration 85
 - trap port
 - system configuration 85
 - TX ARP
 - IP routing 81

Tx bytes 89
Tx frames
 statistics 89
TX RIP
 PPP synchronous protocol 61, 64, 67
Tx RIP 77
Tx signal frame 90

U

UNI 44, 69
UNIT addr
 bisync protocol 55
unit address
 bisync protocol 55
unknown DLCI 90
up arrow 12
user protocol termination 2

V

V.35 2, 8
 adapter cable 8, 107, 110
 bisync protocol 54
 cable 5
 frame relay protocol 42
 PPP async protocol 62, 65
 PPP synchronous protocol 60
 SDLC protocol 47
 transparent async protocol 58
 transparent BOP protocol 52
view DLCI statistics menu
 network port and frame relay protocol only
 93
view protocol statistics menu 94
view statistics 19
virtual circuit 2, 44, 46, 69
 address 1
 permanent 1
 switched 1
virtual circuit sharing 69
virtual connections 1
VT 100 3
 configuration 33
 network port 70

 configuration menu 34
 configuration menu tree 34, 35
 connection to 6
 connection/operation 17
 EIA-232 interface 9
VT 100 interface
 connecting to 7

W

WAN 1
wide area network 1
WND SIZE
 network port 74
WR COM NAME
 system configuration 84
write community name
 system configuration 84

X

XID 22
XMIT RIP
 network port 75

Product Support Information

Pre-sales Inquiries and Applications Support

Please contact your local distributor, ADTRAN Applications Engineering, or ADTRAN Sales:

Applications Engineering (800) 615-1176
Sales (800) 827-0807

Post-Sale Support

Please contact your local distributor first. If your local distributor cannot help, please contact ADTRAN Technical Support and have the unit serial number available.

Technical Support (888) 4ADTRAN

Repair and Return

If ADTRAN Technical Support determines that a repair is needed, Technical Support will coordinate with the Return Material Authorization (RMA) department to issue an RMA number. For information regarding equipment currently in house or possible fees associated with repair, contact RMA directly at the following number:

RMA Department (205) 963-8722

Identify the RMA number clearly on the package, and return to the following address:

ADTRAN, Inc.
RMA Department
901 Explorer Boulevard
Huntsville, Alabama 35806